

KAPPA V EVO

Chiller and air/water heat pump
233÷1750 kW



General information

Air-cooled water chiller unit with semi-hermetic screw compressors and shell and tube evaporators.

Configuration

/HP: Reversible heat pump

/ST: Unit with tank and pumps

/DC: Unit with recovery condenser

/DS: Unit with desuperheater

/LN: Low noise unit

/SLN: Super low noise unit

/A: High-efficiency unit

/A HT: High efficiency and high temperature unit

INDEX

TECHNICAL FEATURES	3
VERSIONS	4
HYDRAULIC MOTOR OPTIONS	4
ACCESSORY VERSIONS	4
ACCESSORIES	5
TECHNICAL DATA KAPPA V EVO	8
TECHNICAL DATA KAPPA V EVO /SLN	11
TECHNICAL DATA KAPPA V EVO /A	14
TECHNICAL DATA KAPPA V EVO /A SLN	17
ELECTRICAL DATA KAPPA V EVO	20
ELECTRICAL DATA KAPPA V EVO /SLN	21
ELECTRICAL DATA KAPPA V EVO /A	22
ELECTRICAL DATA KAPPA V EVO /A SLN	23
OPERATING LIMITS - COOLING - KAPPA V EVO	24
OPERATING LIMITS - HEATING - KAPPA V EVO	24
OPERATING LIMITS - RECOVERY - KAPPA V EVO	25
OPERATING LIMITS - COOLING - KAPPA V EVO /A	26
OPERATING LIMITS - HEATING - KAPPA V EVO /A	26
OPERATING LIMITS - RECOVERY - KAPPA V EVO /A	27
COOLING CAPACITY - KAPPA V EVO	28
HEATING CAPACITY - KAPPA V EVO	31
COOLING CAPACITY - KAPPA V EVO /SLN	33
HEATING CAPACITY - KAPPA V EVO /SLN	36
RECOVERY CAPACITY - KAPPA V EVO	38
COOLING CAPACITY - KAPPA V EVO /A	41
HEATING CAPACITY - KAPPA V EVO /A	44
COOLING CAPACITY - KAPPA V EVO /A SLN	46
HEATING CAPACITY - KAPPA V EVO /A SLN	49
RECOVERY CAPACITY - KAPPA V EVO /A	51
SOUND LEVEL - KAPPA V EVO - STANDARD UNIT	54
SOUND LEVEL - KAPPA V EVO - LOW NOISE UNIT	55
SOUND LEVEL - KAPPA V EVO - SUPER LOW NOISE UNIT	56
SOUND LEVEL - KAPPA V EVO /A- STANDARD UNIT	57
SOUND LEVEL - KAPPA V EVO /A- LOW NOISE UNIT	58
SOUND LEVEL - KAPPA V EVO /A- SUPER LOW NOISE UNIT	59
DIMENSIONAL DATA	60
PRACTICAL RECOMMENDATIONS FOR INSTALLATION	75

TECHNICAL FEATURES

STRUCTURE

Holding frame module realised in galvanised sheet steel and painted with polyester powders RAL 7035 at 180°C, which confer high resistance to atmospheric agents. Stainless steel bolts and screws.

COMPRESSORS

Screw semihermetic compressors with continuous partialisation from 50% to 100% of the load, which enable to maximise the energy yield of the unit in every functioning condition. Start-up and switch off of the machine happen with a partialisation of 25%.

Optimised compressor for functioning of the economiser, from size 61.2 allowing use at all load conditions. On the economiser intake connection, the muffler attenuates the impulses of the ECO line, thus improving silence. The compressors are equipped with a carter heater, ensure lubrication from the pressure difference between flow and intake, independent cooling circuits.

The motor has an electronic integral protection with temperature sensors directly inserted inside the windings and on the flow piping.

Start-up is the "star-triangle" type.

CONDENSERS

Made of finned core coils with copper pipes and high efficiency aluminium fins. The position of the coils enables to reduce the unit dimensions and, at the same time, increase the air intake surface, leaving wide space to position the components of the refrigerant and hydraulic circuits.

In case of two compressors, the condensing sections of the two circuits work autonomously.

ELECTRIC FANS

Of axial type, with conveyor, studied to optimise efficiency and reduce sound emission, directly coupled to 6 poles three phase electric motor, with thermal protection (internal klixon). The protection rating of the motor is IP 54. The fan includes the accident-prevention grill.

EVAPORATOR

Coating and dry expansion shell and tube.

Optimised for use with R134a, allows to improve the unit COP, containing cooling load and overall sizes.

Insulated with a closed cell expanded material coating and equipped with a temperature probe for the anti-freeze protection of every exchanger.

REFRIGERANT CIRCUIT

Includes: compressor flow cock, liquid shut-off cock, load inlet, liquid indicator, solid cartridge dehydrator filter, electronic expansion valve, (also acting as a solenoid valve, closing during stops), pressure transducer for reading, from control, the high and low pressure values and relative evaporation and condensation temperatures, high and low pressure pressure switches and safety valve.

From size 61.2 they are equipped with economiser (braze-wel-

ded plate exchanger) with relative thermostatic valve, solenoid valve on the by-pass line (cooling liquid).

ELECTRIC CONTROL BOARD

The board includes:

- Main isolating switch;
- Fuses to protect the auxiliary and power circuits;
- Compressors remote control switches;
- Fans remote control switches;
- Microprocessor for control of the following functions:
 - Water temperature adjustment, with control of outlet water;
 - Anti-freeze protection;
 - Compressors timing;
 - Compressors start-up sequence automatic rotation;
 - Alarms signal;
 - Alarms reset;
 - Partialisation;
 - Alarm cumulative contact for remote signal;
 - Forcing of partialisation for pressure limit;
 - Registration of alarms history;
- Display of:
 - Temperature of the outlet water;
 - Set temperature and differentials set-point;
 - Description of the alarms;
 - Counter functioning and number of unit, of the compressors and pumps (if present);
 - High and low pressure, and relative condensation and evaporation temperatures.
- Electric power supply [V/f/Hz]: 400/3~/50 ±5%.

CHECKS AND SAFETY DEVICES

- High pressure double pressure switch with manual re-insertion for every compressor;
- High pressure safety with automatic re-insertion at limited interventions managed by control;
- Low pressure safety with automatic re-insertion at limited interventions managed by control;
- High pressure safety valve;
- Anti-freeze probe at the outlet of every evaporator;
- Cooled water temperature control probe (located at system flow);
- Compressors and fans over-temperature protection
- With mechanical blade flow meter supplied;

INSPECTION

The units are inspected in the factory and supplied complete with oil and refrigerant fluid.

VERSIONS

Consult the table of the possible configurations to check whether one options interferes with others.

KAPPA V EVO /A:

High Efficiency Unit

KAPPA V EVO Class A, for energy saving thanks to an EER always greater by 3.1 in functioning in chiller mode! 31 sizes cover a range of powers that go from 249 to 1566 kW respecting the standards set by EUROVENT to enter the highest efficiency energy class. The following diagrams show the increase of energy efficiency to 100% of the load (EER) and to partial loads (ESEER) with respect to the KAPPA V EVO range, according to EUROVENT conditions.

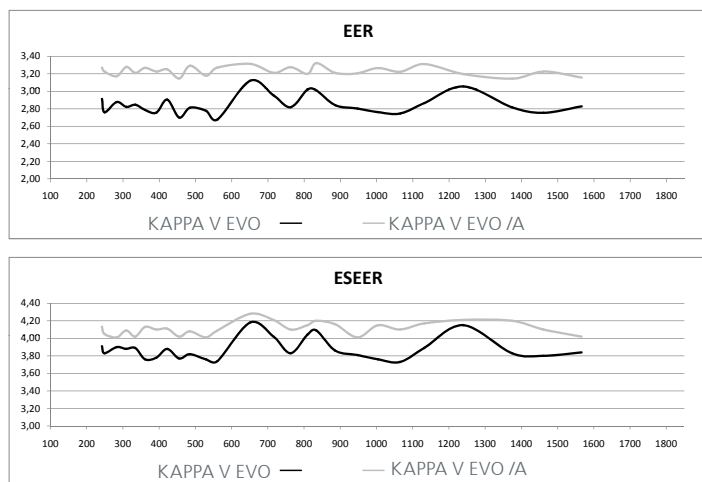

This range, along with the Standard range, has been developed in a series of versions that enrich it and complete it to satisfy all requirements that are presented below.

KAPPA V EVO /HP:

reversible heat pump

As well as the components of the corresponding base range, the units include:

4-way inversion valve, intake separator, liquid accumulator, second electronic expansion valve. Enabling of the microprocessor for summer/winter switch-over and automatic defrosting, with The company Patented logic that allows to optimise the intervention and the duration of defrosting, which is managed independently for every compressor.

HYDRAULIC MOTOR OPTIONS

KAPPA V EVO /ST,

unit with tank and/or pumps

As well as the components of the corresponding base range, the unit includes according to the configurations indicated below: insulated storage tank, 1/2 circulation pumps, (one in stand-by if two pumps) with timed automatic commutation and in case of damage. Expansion tanks, check valve, shutter.

The ST version is available in four possible configurations:

- ST 2PS: with 2 pumps with tank;
- ST 1PS: with 1 pump with tank;
- ST 2P: with 2 pumps without tank;

- ST 1P: with 1 pump without tank.

ACCESSORY VERSIONS

KAPPA V EVO /DC:

unit with recovery condenser

As well as the components of the corresponding base range, on every refrigerant circuit the unit includes a recovery condenser of 100% of the condensation heat for the production of hot water, a liquid receiver and the refrigerant system for emptying the refrigerant fluid from the condensing coil, when necessary, when recovery is activated. The condenser might be as shell or tube type. The control automatically manages the activation of the recovery on the basis of the water temperature and the deactivation of the safety device of the recovery itself due to high pressure. Not available in the HP version.

KAPPA V EVO /DS:

unit with desuperheaters

As well as the components of the corresponding basic version, on every refrigerant circuit the unit has a recovery heat exchanger of 20% of condensation heat, placed in series with the condensing coil. The heat exchanger is the braze-welded plate type or shell and tube. To maximise the use of the accessory, coupling with the fan rev. regulator is recommended. This version is also available in the HP set-up. In this case the interception of the recovery water circuit must be envisioned in installation during functioning in HP mode, as indicated in the manual.

KAPPA V EVO /LN:

low noise unit

As well as the components of the corresponding base range, the unit envisions the compressors compartment completely noise insulated with sound absorbing material and sound impeding material and fan revs regulator (the noise of the fans decreases with the decrease in power requested by the system and/or of the external temperature).

KAPPA V EVO /SLN:

super low noise unit

As well as the components of the KAPPA V EVO /LN version, coils with larger surfaces are envisioned.

As well as the versions just described, the high efficiency range also has the solution for high temperatures:

KAPPA V EVO A /HT:

high efficiency unit for high temperatures

The unit allows to work with high external air temperatures as highlighted in the functioning limits indicated in the dedicated sections. Thanks to the compressors with dedicated electric motor, the HT version also allows to reach temperatures of water produced that are higher than the standard range. However, it remains a version in class A thanks to the combination of construction solutions that couple the high efficiency and attainment of high temperatures. In fact, as well as that said, especially selected fans are envisioned. Finally, tropicalisation of the electric control board is prevented by forced ventilation inside the same and via a means of appropriate dimensioning

of the components.

ACCESSORIES

REFRIGERANT CIRCUIT ACCESSORIES

- Check condensation pressure via revs regulator for functioning with low outdoor temperatures and/or to decrease machine noise when possible;
- Double set point; (high/low temperature) with unique electronic expansion valve. The unit evaporator is sized depending on the high temperature functioning. The set point change can be carried out from keyboard or digital input, in this case it must be specified when ordering;
- High and low pressure manometer available for all models (the intake and flow pressures can be detected from the control display also in standard machine setting);
- Liquid receivers (as per standard in HP and DC versions);
- Compressors intake cocks;
- Liquid line solenoid valve (however the electronic expansion valve cuts-off the liquid line when the compressor stops);
- Buffer battery for electronic thermostatic valve;
- Brine Kit.

HYDRAULIC CIRCUIT ACCESSORIES

- Anti-freeze resistance for evaporator (an anti-freeze resistance is also installed on the tank in the ST execution, on pumps piping and tank) and on any recovery exchangers;
- Water side safety valve (only ST version);
- Inverter driven pump.

ELECTRIC ACCESSORIES

- RS485, Modbus, LonWorks, Bacnet, Ethernet, SNMP, FTP, HTTP serial interface;
- Power factor correction of the nominal functioning conditions on external unit in IP 55 (electric power supply under the responsibility of the installer directly from the main line);
- Remote user terminal (in addition to standard one);
- Variable set point with remote signal (0-1V, 0-1 OV, 0-20mA, 4-20mA);
- Potential free functioning contacts;
- R el e PSM management with one or two pumps;
- Electronic soft-starter;
- Absorbed current limit.
- Automatic circuit breakers;
- Maximum and minimum voltage relay;
- Power supply 415/3/50
- SLAT;
- EC fans;
- Automatic circuit breakers for compressors and fans;
- SMARTLINK.

VARIOUS ACCESSORIES

- Spring or rubber anti-vibration mounts;
- Condensing coil in pre-painted aluminium;
- Condensing coil with passivation treatment of the aluminium and polyurethanic base cover. Treatment consists in a double layer of which the first is a passivation of the aluminium with primer function, and the second is a polyurethane base superficial covering layer.

- The product is highly resistant to corrosion and to basically all environmental situations. From installations in nautical environments to rural environments, from industrial areas to urban areas;
- Special pallet/slide for container shipment;
- Coil protection mesh with metal hail protection filter (version HP excluded).

DOUBLE SET POINT

The microprocessor enables you to set two set temperatures for the production of cold and hot water. Unless specified otherwise in the order, the default values are 12/7 °C and 15/10 °C for chiller mode and 40/45 °C and 35/40 °C for heat pump mode. The set temperatures must, in any case, remain within the operating ranges of the unit.

Use either the keypad or the digital input to switch between the first and second set. For series that do not permit the simultaneous selection of "Select summer/winter mode with digital input" and "Double set point with digital input", summer/winter mode can be selected only on the keypad while the double set point still uses the digital input, as per our standard.

EC FANS

Units can be coupled to the innovative direct current EC axial fans with electronically commutated brushless motor.

These motors with permanent magnets rotor ensure a high level of efficiency for all work conditions and allow to obtain a 15% saving per fan.

Moreover, through a 0-10V analogical signal sent to every fan, the microprocessor allows to control the condensation through continuous air flow regulations on variation of the outdoor air temperature and a consequent sound emission reduction

"BRINE KIT" ACCESSORY

It is applied if the evaporator output temperature is included within +3°C and -8°C. It consists in a higher thermal insulation of the exchanger and piping, a specific calibration of the low pressure switches and of the anti-freeze alarm, and dimensioning check of the mechanical thermostatic valve.

If it is not included in the set-up, the "Check condensation" accessory must be added.

"SLAT ACCESSORY: Set low air temperature"

This accessory is available only for the chiller version of KAPPA V EVO E KAPPA V EVO A units (heat pump excluded): in absence of wind and in addition to the "Condensation control with fan speed governor" accessory, it allows extending operating limits from -10 C to -20 C of external air. This extension is obtained by a different calibration of the control parameters.

INVERTER DRIVEN PUMP (For ST1P/S or ST2P/S)

Energy savings:

Variable flow pumps have become more widespread over the years to optimise air conditioning and cooling systems. Thanks to the Inverter Driven Pump, The company offers an alternative method that differs from conventional layouts: a constant flow primary pump and a variable flow secondary pump

Let's compare the two solutions:

1) The figure below shows the layout of a constant flow primary pump and a variable flow secondary pump. Please note the use of the decoupling pipe between the primary and secondary system (designed to cover the entire flow rate): if the utilities only require a percentage of the nominal power, the decoupling pipe recirculates the excess flow, which means wasting pumping energy.

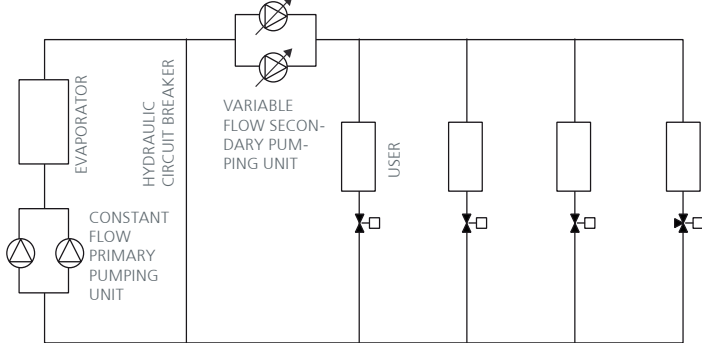

The figure below shows a system with only variable flow primary pumps, which also serve the secondary system. The bypass pipe and the two-way control valve ensure minimum water flow through the evaporator when the request is below the allowed minimum water flow limit to guarantee a correct heat exchange for the evaporator. The pipe and the two-way control valve are designed for a much lower water flow rate than the nominal one. This allows to considerably reduce energy losses related to the mixing process, which in traditional systems are caused by the hydraulic circuit breaker.

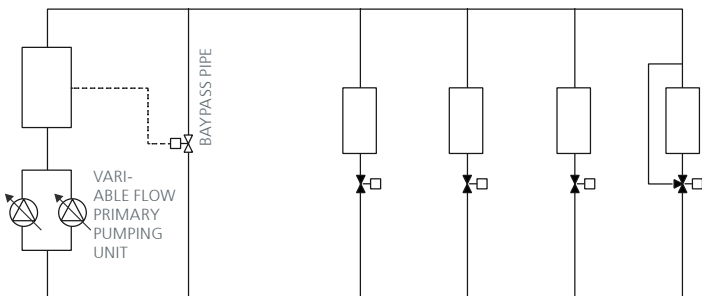

Benefits of the Inverter Driven Pump:

- Saving a set of pumps
- Reduced overall dimensions of the machines' housings
- Lower piping costs
- Reduced pressure drops
- Greater energy efficiency on the pump side

As we can see from the graph under EUROVENT conditions, the systems in the diagrams have higher efficiency under part-load conditions, considering the energy consumed by the pumps as well as by the chiller (compressors plus fans)

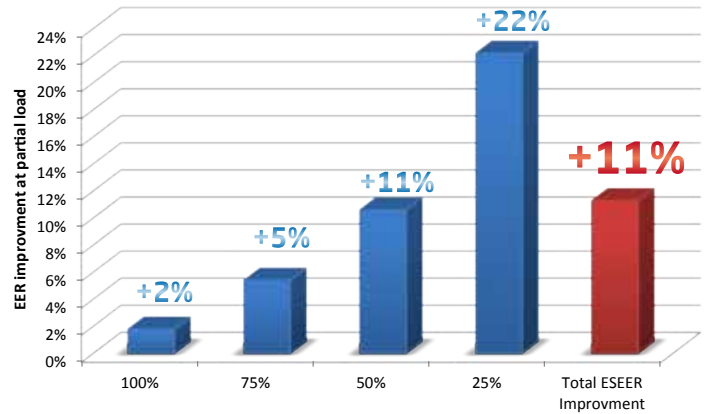

Energy savings in these conditions can be as high as 11% per year and sometimes even more!

Inverter Driven Pump operating logic:

Dp1: System side pressure drops

Dp2: Evaporator pressure drops

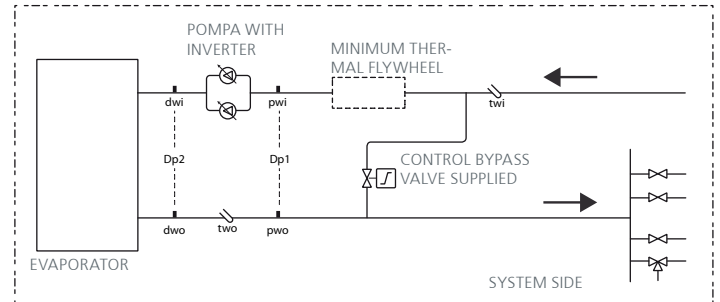

When all the utilities are in operation, the unit's pump runs at the nominal flow rate and with an available head on the system side equal to Dp1 and evaporator pressure drops equal to Dp2.

The system's heat load drop causes the shut-off valves of the utilities to close, which results in an increase in the pressure drops that the pump needs to overcome. At the same time, the inverter's control logic will reduce the flow rate, which will determine lower evaporator pressure drops and bring back the available head to the nominal Dp1 value.

Key points for a variable flow primary system:

In order for the components of the system to operate optimally, it is important to take some key points into account:

1) Minimum water flow and bypass valve supplied:

The Inverter Driven Pump also includes the two-way bypass valve supplied with it and adequately designed in relation to the size of the unit.

If on the system side the heat load is very low, this means that many utilities are closed, which results in an increase in pressure drops. The inverter counters the Dp1 variation detected by the sensor by reducing the speed of the pump and the flow rate as a result. However, there is a limit lower than the flow rate value below which the heat exchange towards the evaporator is not performed properly and the temperature drop processed by the evaporator increases, which might activate the anti-freeze alarm. The two-way control valve adequately selected based on the machine model prevents this alarm from being triggered, thereby ensuring the minimum water flow

rate towards the evaporator.

2) "Minimum thermal flywheel":

In the event of a heat load close to zero, with the unit in maximum power partialisation conditions, the pump set at the minimum flow rate and closed system valves, the machine might stop due to the anti-freeze alarm.

To prevent this problem, there must be a "minimum thermal flywheel" in the evaporator / bypass valve section.

Below is the formula to determine it:

$$Vol = \frac{P_0 * k}{N} \quad [l]$$

P_0 Machine overall chilling power[kW]

N : Inverse of the unit's minimum partialisation

k : parameter [l/kW]

Screw compressors		1	2	4
k	[l/kW]	14.3	14.3	14.3
N		2	4	8

The water content of the evaporator, of the hydraulic module's inertial tank (if there is one) and of the pipes between the bypass and the evaporator itself may contribute to determine the "minimum thermal flywheel".

On users more distant from the machine it's strongly recommended to use 3-way valves and a gate valve calibration that colleagues the final part of the ridges of the plant, in order to ensure a minimum water flow through the plant in any condition.

Please note: if this accessory is installed, the minimum cold water temperature at the outlet cannot drop below 7°C. Moreover, the temperature variation considered under the conditions specified in the project must be 5°C. Please contact our sales department for the minimum water temperature at the outlet (production of cold water) and for different temperature drop values.

You should also contact the sales department in the event of production of hot water for water temperatures at the outlet below 40°C.

Attention: the "minimum thermal flywheel" must be between the bypass valve and the evaporator. This is a part of the "minimum water content of the system" described in the relative chapter of the manual; the difference between the "minimum water content of the system" and the "minimum thermal flywheel" can instead be positioned in any area of the system.

The "minimum thermal flywheel" allows the unit to operate correctly also in heat pump mode.

For cooling-only machines, if using ethylene glycol mixes, it is possible to reduce the "minimum thermal flywheel" based on the curves below

For screw compressors:

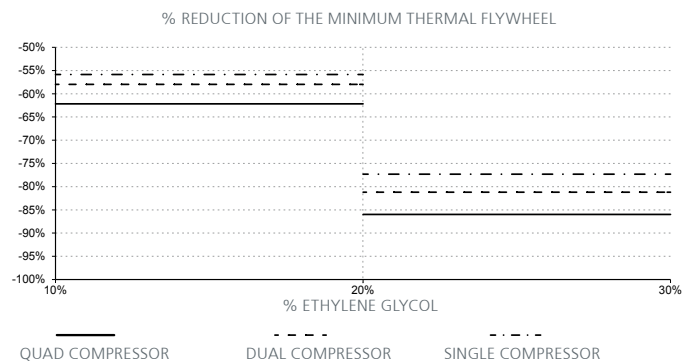

If the unit is in heat pump mode, the "minimum thermal flywheel" is not reduced even if there is glycol.

TECHNICAL DATA KAPPA V EVO

UNIT SIZE			23.1	25.1	28.1	31.1	33.2	35.2	37.2	40.2	43.2	47.2	51.2
Cooling (Gross values)													
Nominal cooling capacity	(1)	kW	233	254	282	302	326	351	372	401	438	467	494
Total power input for cooling	(1)(2)	kW	80	92	98	107	115	126	135	146	151	173	175
EER	(1)		2,91	2,76	2,88	2,82	2,85	2,79	2,77	2,76	2,91	2,70	2,81
ESEER			3,91	3,83	3,90	3,88	3,89	3,76	3,80	3,78	3,88	3,77	3,82
Efficiency class			B	C	C	C	C	C	C	C	B	D	C
Cooling (EN 14511 values)													
Nominal cooling capacity	(1)(8)	kW	232	253	281	301	325	350	370	399	437	466	492
EER	(1)(8)		2,87	2,72	2,83	2,78	2,80	2,74	2,72	2,71	2,87	2,67	2,78
ESEER	(8)		3,71	3,61	3,67	3,64	3,66	3,53	3,55	3,53	3,70	3,58	3,62
Efficiency class			C	C	C	C	C	C	C	C	C	D	C
Heating (Gross values)													
Nominal heating capacity	(3)	kW	229	260	283	308	333	351	381	402	442	478	494
Total power input for heating	(2)(3)	kW	71	79	86	93	104	118	121	125	155	156	159
COP	(3)		3,23	3,29	3,29	3,31	3,22	2,97	3,15	3,23	2,85	3,06	3,11
Efficiency class			A	A	A	A	A	C	B	A	C	B	B
Heating (EN 14511 values)													
Nominal heating capacity	(3)(8)	kW	230	261	284	309	334	353	383	404	443	480	496
COP	(3)(8)		3,20	3,26	3,26	3,28	3,19	2,95	3,12	3,20	2,84	3,04	3,09
Efficiency class			B	A	A	A	B	C	B	B	C	B	B
Compressors													
Type			Screw										
Quantity/Cooling circuits		n°/n°	1 / 1	1 / 1	1 / 1	1 / 1	2 / 2	2 / 2	2 / 2	2 / 2	2 / 2	2 / 2	2 / 2
Partialisation steps		n°/n°	Continue										
Total oil load		kg	15	18	20	23	32	32	32	32	31	33	36
Total cooling load (version CH)		kg	35	36	40	42	60	63	65	69	73	73	73
Total cooling load (version HP)		kg	37	38	42	45	62	64	67	70	75	75	75
Fans													
Type			Axials										
Quantity		n°	4	4	4	4	6	6	6	6	8	8	8
Air flow rate		m ³ /h	88.000	88.000	86.000	86.000	140.078	140.078	140.078	140.078	182.000	182.000	182.000
Evaporators													
Type			Shell and tube										
Quantity		n°	1	1	1	1	1	1	1	1	1	1	1
KAPPA V EVO water flow rate		l/h	40.069	43.680	48.495	51.935	56.062	60.432	63.972	68.960	75.321	80.310	84.905
KAPPA V EVO pressure drop	(6)	kPa	40	47	47	53	48	53	57	58	35	38	42
	(7)	kPa	39	49	47	55	50	53	60	58	36	40	42
Hydraulic module													
Useful static pressure	(9)	kPa	204	205	188	169	191	177	164	233	222	209	199
Storage tank capacity	(9)	l	585	585	585	585	-	-	-	-	740	740	740
Expansion tank		l	25	25	25	25	25	25	25	25	25	25	25
Noise													
Sound power level (basic unit)	(4)	dB(A)	93	93	93	94	94	95	95	96	96	97	97
Sound pressure level (basic unit)	(5)	dB(A)	61	61	61	62	62	63	63	64	64	65	65
Sound power level (LN version)	(4)	dB(A)	87	87	87	88	89	89	89	90	90	91	91
Sound pressure level (LN version)	(5)	dB(A)	55	55	55	56	57	57	57	58	58	59	59
Dimensions and base unit weights													
Length		mm	3.246	3.246	3.246	3.246	4.263	4.263	4.263	4.263	4.761	4.761	4.761
Depth		mm	2.315	2.315	2.315	2.315	2.315	2.315	2.315	2.315	2.315	2.315	2.315
Height		mm	2.402	2.402	2.402	2.402	2.402	2.402	2.402	2.402	2.402	2.402	2.402
Weight when functioning		kg	2.440	2.510	2.582	2.640	3.458	3.416	3.478	3.506	3.854	4.042	4.114

(1) External air temperature 35°C; input water-evaporator output temperature 12-7°C

(2) The total power is given by the sum of the power absorbed by the compressors and by the fans

(3) External air temperature 7°C DB, 6°C WB; condenser input-output temperature 40-45°C

(4) Sound power levels calculated compliant to ISO 3744

(5) Sound pressure levels refer to 10 meters from unit in free field and directionality factor Q=2

(6) Evaporator inlet-outlet water temperature 12-7°C

(7) Condenser inlet-outlet water temperature 40-45°C

(8) Values in compliance with EN 14511-3:2011

(9) In ST 2PS version

This board reports the feature data of the base and standard versions; for details, refer to the specific documentation.

TECHNICAL DATA KAPPA V EVO

UNIT SIZE			54.2	58.2	61.2	67.2	70.2	73.2	80.2	82.2	85.2	90.2	95.2
Cooling (Gross values)													
Nominal cooling capacity	(1)	kW	530	584	637	667	699	729	775	812	856	894	940
Total power input for cooling	(1)(2)	kW	191	218	204	215	244	247	275	269	284	315	335
EER	(1)		2,78	2,68	3,12	3,11	2,87	2,95	2,82	3,02	3,01	2,84	2,80
ESEER			3,76	3,74	4,18	4,19	3,89	4,02	3,83	4,04	4,09	3,86	3,81
Efficiency class			C	D	A	A	C	B	C	B	B	C	C
Cooling (EN 14511 values)													
Nominal cooling capacity	(1)(8)	kW	528	582	636	665	697	727	772	809	853	891	937
EER	(1)(8)		2,74	2,64	3,09	3,07	2,84	2,91	2,78	2,98	2,97	2,80	2,77
ESEER	(8)		3,56	3,50	3,99	3,99	3,69	3,80	3,61	3,81	3,84	3,61	3,59
Efficiency class			C	D	B	B	C	B	C	B	B	C	C
Heating (Gross values)													
Nominal heating capacity	(3)	kW	547	615	629	656	715	726	780	-	-	-	-
Total power input for heating	(2)(3)	kW	185	187	188	196	210	215	228	-	-	-	-
COP	(3)		2,95	3,29	3,35	3,36	3,41	3,38	3,43	-	-	-	-
Efficiency class			C	A	A	A	A	A	A	-	-	-	-
Heating (EN 14511 values)													
Nominal heating capacity	(3)(8)	kW	549	618	631	658	717	728	783	-	-	-	-
COP	(3)(8)		2,93	3,26	3,33	3,33	3,39	3,36	3,40	-	-	-	-
Efficiency class			C	A	A	A	A	A	A	-	-	-	-
Compressors													
Type			Screw										
Quantity/Cooling circuits		n°/n°	2 / 2	2 / 2	2 / 2	2 / 2	2 / 2	2 / 2	2 / 2	2 / 2	2 / 2	2 / 2	2 / 2
Partialisation steps		n°/n°	Continue										
Total oil load		kg	40	46	38	40	46	43	46	46	51	56	56
Total cooling load (version CH)		kg	95	96	117	119	122	128	144	139	141	141	159
Total cooling load (version HP)		kg	98	99	120	121	124	131	148	-	-	-	-
Fans													
Type			Axials										
Quantity		n°	8	8	10	10	10	10	10	12	12	12	12
Air flow rate		m ³ /h	174.800	174.800	218.000	218.000	218.000	218.000	206.000	262.000	262.000	262.000	257.000
Evaporators													
Type			Shell and tube										
Quantity		n°	1	1	1	1	1	1	1	1	1	1	1
KAPPA V EVO water flow rate		l/h	91.058	100.430	109.579	114.731	120.206	125.446	133.230	139.639	147.152	153.740	161.599
KAPPA V EVO pressure drop	(6)	kPa	43	56	33	36	39	43	47	47	51	55	46
	(7)	kPa	46	62	32	35	41	43	48	-	-	-	-
Hydraulic module													
Useful static pressure	(9)	kPa	206	180	186	180	164	154	214	203	190	190	239
Storage tank capacity	(9)	l	740	740	740	740	740	740	740	900	900	900	900
Expansion tank		l	25	25	25	25	25	25	25	25	25	25	25
Noise													
Sound power level (basic unit)	(4)	dB(A)	98	98	99	99	99	100	100	100	100	100	101
Sound pressure level (basic unit)	(5)	dB(A)	66	65	66	66	66	67	67	67	67	67	68
Sound power level (LN version)	(4)	dB(A)	92	92	92	93	93	94	94	94	94	95	95
Sound pressure level (LN version)	(5)	dB(A)	60	59	59	60	60	61	61	61	61	62	62
Dimensions and base unit weights													
Length		mm	4.761	4.761	5.761	5.761	5.761	5.761	5.761	6.761	6.761	6.761	6.761
Depth		mm	2.315	2.315	2.315	2.315	2.315	2.315	2.315	2.315	2.315	2.315	2.315
Height		mm	2.402	2.402	2.402	2.402	2.402	2.402	2.402	2.402	2.402	2.402	2.402
Weight when functioning		kg	4.126	4.248	5.218	5.178	5.300	5.284	5.648	5.472	5.769	5.878	6.333

(1) External air temperature 35°C; input water-evaporator output temperature 12-7°C

(2) The total power is given by the sum of the power absorbed by the compressors and by the fans

(3) External air temperature 7°C DB, 6°C WB; condenser input-output temperature 40-45°C

(4) Sound power levels calculated compliant to ISO 3744

(5) Sound pressure levels refer to 10 meters from unit in free field and directionality factor Q=2

(6) Evaporator inlet-outlet water temperature 12-7°C

(7) Condenser inlet-outlet water temperature 40-45°C

(8) Values in compliance with EN 14511-3:2011

(9) In ST 2PS version

This board reports the feature data of the base and standard versions; for details, refer to the specific documentation.

TECHNICAL DATA KAPPA V EVO

UNIT SIZE			100.2	105.2	110.2	115.2	120.2	130.2	140.2	150.4	160.4	180.4
Cooling (Gross values)												
Nominal cooling capacity	(1)	kW	978	1027	1078	1175	1272	1307	1361	1460	1551	1750
Total power input for cooling	(1)(2)	kW	354	376	393	410	417	457	483	530	549	659
EER	(1)		2,76	2,74	2,75	2,87	3,05	2,86	2,82	2,75	2,83	2,66
ESEER			3,76	3,81	3,73	3,89	4,15	3,89	3,83	3,80	3,84	3,73
Efficiency class			C	C	C	C	B	C	C	C	C	D
Cooling (EN 14511 values)												
Nominal cooling capacity	(1)(8)	kW	975	1023	1076	1172	1269	1303	1357	1456	1547	1744
EER	(1)(8)		2,73	2,69	2,72	2,84	3,02	2,83	2,78	2,73	2,80	2,62
ESEER	(8)		3,54	3,56	3,58	3,71	3,94	3,68	3,62	3,61	3,64	3,49
Efficiency class			C	D	C	C	B	C	C	C	C	D
Heating (Gross values)												
Nominal heating capacity	(3)	kW	-	-	-	-	-	-	-	-	-	-
Total power input for heating	(2)(3)	kW	-	-	-	-	-	-	-	-	-	-
COP	(3)		-	-	-	-	-	-	-	-	-	-
Efficiency class			-	-	-	-	-	-	-	-	-	-
Heating (EN 14511 values)												
Nominal heating capacity	(3)(8)	kW	-	-	-	-	-	-	-	-	-	-
COP	(3)(8)		-	-	-	-	-	-	-	-	-	-
Efficiency class			-	-	-	-	-	-	-	-	-	-
Compressors												
Type								Screw				
Quantity/Cooling circuits		n°/n°	2 / 2	2 / 2	2 / 2	2 / 2	2 / 2	2 / 2	2 / 2	4 / 4	4 / 4	4 / 4
Partialisation steps		n°/n°						Continue				
Total oil load		kg	56	56	56	56	50	50	50	80	92	112
Total cooling load (version CH)		kg	173	185	187	188	196	219	242	246	288	295
Total cooling load (version HP)		kg	-	-	-	-	-	-	-	-	-	-
Fans												
Type								Axials				
Quantity		n°	12	14	14	16	16	16	16	20	20	20
Air flow rate		m ³ /h	252.000	304.000	304.000	354.000	354.000	348.000	342.000	436.000	412.000	412.000
Evaporators												
Type								Shell and tube				
Quantity		n°	1	1	1	1	1	1	1	2	2	2
KAPPA V EVO water flow rate		l/h	168.229	176.612	185.365	202.064	218.798	224.690	234.101	251.075	266.738	300.946
KAPPA V EVO pressure drop	(6)	kPa	49	59	28	33	39	42	44	37	40	54
	(7)	kPa	-	-	-	-	-	-	-	-	-	-
Hydraulic module												
Useful static pressure	(9)	kPa	237	209	225	209	185	212	201	189	172	214
Storage tank capacity	(9)	l	900	900	900	900	900	900	900	-	-	-
Expansion tank		l	25	25	25	25	25	25	25	25	25	25
Noise												
Sound power level (basic unit)	(4)	dB(A)	101	102	102	102	102	103	103	103	103	104
Sound pressure level (basic unit)	(5)	dB(A)	68	69	69	69	69	70	70	70	70	71
Sound power level (LN version)	(4)	dB(A)	95	96	96	96	97	97	97	97	97	98
Sound pressure level (LN version)	(5)	dB(A)	62	63	63	63	64	64	64	64	64	65
Dimensions and base unit weights												
Length		mm	6.761	7.761	7.761	9.261	9.261	9.261	9.261	11.143	11.143	11.143
Depth		mm	2.315	2.315	2.315	2.315	2.315	2.315	2.315	2.315	2.315	2.315
Height		mm	2.402	2.402	2.402	2.402	2.402	2.402	2.402	2.402	2.402	2.402
Weight when functioning		kg	6.420	6.981	7.043	7.883	8.130	8.650	8.674	10.584	11.180	11.612

(1) External air temperature 35°C; input water-evaporator output temperature 12-7°C

(2) The total power is given by the sum of the power absorbed by the compressors and by the fans

(3) External air temperature 7°C DB, 6°C WB; condenser input-output temperature 40-45°C

(4) Sound power levels calculated compliant to ISO 3744

(5) Sound pressure levels refer to 10 meters from unit in free field and directionality factor Q=2

(6) Evaporator inlet-outlet water temperature 12-7°C

(7) Condenser inlet-outlet water temperature 40-45°C

(8) Values in compliance with EN 14511-3:2011

(9) In ST 2PS version

This board reports the feature data of the base and standard versions; for details, refer to the specific documentation.

TECHNICAL DATA KAPPA V EVO /SLN

UNIT SIZE			23.1	25.1	28.1	31.1	33.2	35.2	37.2	40.2	43.2	47.2	51.2
Cooling (Gross values)													
Nominal cooling capacity	(1)	kW	232	253	275	294	324	349	370	399	438	465	492
Total power input for cooling	(1)(2)	kW	78	90	99	108	112	123	132	145	151	173	185
EER	(1)		2,96	2,80	2,78	2,72	2,90	2,84	2,80	2,75	2,91	2,69	2,66
ESEER			3,93	3,84	3,85	3,83	3,91	3,78	3,81	3,77	3,88	3,76	3,81
Efficiency class			B	C	C	C	C	C	C	C	B	D	D
Cooling (EN 14511 values)													
Nominal cooling capacity	(1)(8)	kW	231	252	274	293	323	348	368	397	437	463	490
EER	(1)(8)		2,92	2,75	2,74	2,68	2,85	2,79	2,75	2,70	2,87	2,66	2,63
ESEER	(8)		3,73	3,62	3,64	3,60	3,68	3,55	3,56	3,52	3,70	3,57	3,61
Efficiency class			B	C	C	D	C	C	C	C	C	D	D
Heating (Gross values)													
Nominal heating capacity	(3)	kW	234	265	280	305	340	358	389	410	451	488	504
Total power input for heating	(2)(3)	kW	70	78	84	91	102	117	119	123	153	154	157
COP	(3)		3,35	3,41	3,35	3,37	3,34	3,07	3,26	3,34	2,95	3,17	3,22
Efficiency class			A	A	A	A	A	B	A	A	C	B	A
Heating (EN 14511 values)													
Nominal heating capacity	(3)(8)	kW	234	266	281	306	341	360	391	412	452	489	506
COP	(3)(8)		3,32	3,37	3,32	3,33	3,31	3,05	3,22	3,30	2,93	3,15	3,19
Efficiency class			A	A	A	A	A	B	A	A	C	B	B
Compressors													
Type			Screw										
Quantity/Cooling circuits		n°/n°	1 / 1	1 / 1	1 / 1	1 / 1	2 / 2	2 / 2	2 / 2	2 / 2	2 / 2	2 / 2	2 / 2
Partialisation steps		n°/n°	Continue										
Total oil load		kg	15	18	20	23	32	32	32	32	31	33	36
Total cooling load (version CH)		kg	35	36	40	42	60	63	65	69	73	73	73
Total cooling load (version HP)		kg	37	38	42	45	62	64	67	70	75	75	75
Fans													
Type			Axials										
Quantity		n°	4	4	4	4	6	6	6	6	8	8	8
Air flow rate		m3/h	71.000	71.000	68.000	68.000	105.000	105.000	105.000	105.000	133.000	133.000	133.000
Evaporators													
Type			Shell and tube										
Quantity		n°	1	1	1	1	1	1	1	1	1	1	1
KAPPA V EVO water flow rate		l/h	39.868	43.462	47.283	50.636	55.782	60.059	63.653	68.615	75.288	79.908	84.528
KAPPA V EVO pressure drop	(6)	kPa	40	47	45	50	48	52	56	57	35	38	42
	(7)	kPa	40	51	46	54	52	55	62	61	37	41	44
Hydraulic module													
Useful static pressure	(9)	kPa	204	205	188	169	191	177	164	233	222	209	199
Storage tank capacity	(9)	l	585	585	585	585	-	-	-	-	740	740	740
Expansion tank		l	25	25	25	25	25	25	25	25	25	25	25
Noise													
Sound power level (SLN version)	(4)	dB(A)	82	82	83	83	83	84	84	85	85	85	85
Sound pressure level (SLN version)	(5)	dB(A)	50	50	51	51	51	52	52	53	53	53	53
Dimensions and base unit weights													
Length		mm	3.246	3.246	3.246	3.246	4.263	4.263	4.263	4.263	4.761	4.761	4.761
Depth		mm	2.315	2.315	2.315	2.315	2.315	2.315	2.315	2.315	2.315	2.315	2.315
Height		mm	2.402	2.402	2.402	2.402	2.402	2.402	2.402	2.402	2.402	2.402	2.402
Weight when functioning		kg	2.650	2.720	2.790	2.852	3.906	3.866	3.926	3.956	4.294	4.482	4.554

(1) External air temperature 35°C; input water-evaporator output temperature 12-7°C

(2) The total power is given by the sum of the power absorbed by the compressors and by the fans

(3) External air temperature 7°C DB, 6°C WB; condenser input-output temperature 40-45°C

(4) Sound power levels calculated compliant to ISO 3744

(5) Sound pressure levels refer to 10 meters from unit in free field and directionality factor Q=2

(6) Evaporator inlet-outlet water temperature 12-7°C

(7) Condenser inlet-outlet water temperature 40-45°C

(8) Values in compliance with EN 14511-3:2011

(9) In ST 2PS version

This board reports the feature data of the base and standard versions; for details, refer to the specific documentation.

TECHNICAL DATA KAPPA V EVO /SLN

UNIT SIZE			54.2	58.2	61.2	67.2	70.2	73.2	80.2	82.2	85.2	90.2	95.2
Cooling (Gross values)													
Nominal cooling capacity	(1)	kW	517	569	621	650	682	713	736	792	826	872	914
Total power input for cooling	(1)(2)	kW	198	219	210	224	246	255	278	271	294	319	347
EER	(1)		2,61	2,60	2,96	2,90	2,77	2,80	2,65	2,92	2,81	2,73	2,63
ESEER			3,71	3,69	4,13	4,14	3,84	3,97	3,73	3,99	4,02	3,81	3,76
Efficiency class			D	D	B	B	C	C	D	B	C	C	D
Cooling (EN 14511 values)													
Nominal cooling capacity	(1)(8)	kW	515	567	619	649	680	710	734	789	823	868	911
EER	(1)(8)		2,58	2,57	2,93	2,87	2,74	2,76	2,62	2,89	2,78	2,69	2,60
ESEER	(8)		3,52	3,46	3,95	3,94	3,65	3,76	3,53	3,77	3,79	3,58	3,55
Efficiency class			D	D	B	C	C	C	D	C	C	D	D
Heating (Gross values)													
Nominal heating capacity	(3)	kW	541	609	623	649	708	719	749	-	-	-	-
Total power input for heating	(2)(3)	kW	180	182	181	189	203	208	218	-	-	-	-
COP	(3)		3,00	3,34	3,43	3,43	3,48	3,45	3,44	-	-	-	-
Efficiency class			C	A	A	A	A	A	A	-	-	-	-
Heating (EN 14511 values)													
Nominal heating capacity	(3)(8)	kW	543	612	624	651	710	721	751	-	-	-	-
COP	(3)(8)		2,98	3,31	3,41	3,41	3,45	3,42	3,41	-	-	-	-
Efficiency class			C	A	A	A	A	A	A	-	-	-	-
Compressors													
Type													
Quantity/Cooling circuits		n°/n°	2 / 2	2 / 2	2 / 2	2 / 2	2 / 2	2 / 2	2 / 2	2 / 2	2 / 2	2 / 2	2 / 2
Partialisation steps		n°/n°											
Total oil load		kg	40	46	38	40	46	43	46	46	51	56	56
Total cooling load (version CH)		kg	95	96	117	119	122	128	144	139	141	141	159
Total cooling load (version HP)		kg	98	99	120	121	124	131	148	-	-	-	-
Fans													
Type													
Quantity		n°	8	8	10	10	10	10	10	12	12	12	12
Air flow rate		m ³ /h	127.000	127.000	158.000	158.000	158.000	158.000	158.000	188.000	188.000	188.000	188.000
Evaporators													
Type													
Quantity		n°	1	1	1	1	1	1	1	1	1	1	1
KAPPA V EVO water flow rate		l/h	88.865	97.919	106.806	111.836	117.201	122.567	126.612	136.148	142.016	149.897	157.180
KAPPA V EVO pressure drop	(6)	kPa	41	53	31	34	37	41	42	45	48	52	44
	(7)	kPa	45	61	32	34	40	42	44	-	-	-	-
Hydraulic module													
Useful static pressure	(9)	kPa	206	180	186	180	164	154	214	203	190	190	239
Storage tank capacity	(9)	l	740	740	740	740	740	740	740	900	900	900	900
Expansion tank		l	25	25	25	25	25	25	25	25	25	25	25
Noise													
Sound power level (SLN version)	(4)	dB(A)	86	86	86	87	87	88	88	88	89	90	90
Sound pressure level (SLN version)	(5)	dB(A)	54	53	53	54	54	55	55	55	56	57	57
Dimensions and base unit weights													
Length		mm	4.761	4.761	5.761	5.761	5.761	5.761	5.761	6.761	6.761	6.761	6.761
Depth		mm	2.315	2.315	2.315	2.315	2.315	2.315	2.315	2.315	2.315	2.315	2.315
Height		mm	2.402	2.402	2.402	2.402	2.402	2.402	2.402	2.402	2.402	2.402	2.402
Weight when functioning		kg	4.566	4.688	5.618	5.618	5.700	5.684	6.044	5.876	6.168	6.276	6.732

(1) External air temperature 35°C; input water-evaporator output temperature 12-7°C

(2) The total power is given by the sum of the power absorbed by the compressors and by the fans

(3) External air temperature 7°C DB, 6°C WB; condenser input-output temperature 40-45°C

(4) Sound power levels calculated compliant to ISO 3744

(5) Sound pressure levels refer to 10 meters from unit in free field and directionality factor Q=2

(6) Evaporator inlet-outlet water temperature 12-7°C

(7) Condenser inlet-outlet water temperature 40-45°C

(8) Values in compliance with EN 14511-3:2011

(9) In ST 2PS version

This board reports the feature data of the base and standard versions; for details, refer to the specific documentation.

TECHNICAL DATA KAPPA V EVO /SLN

UNIT SIZE			100.2	105.2	110.2	115.2	120.2	130.2	140.2	150.4	160.4	180.4
Cooling (Gross values)												
Nominal cooling capacity	(1)	kW	951	1001	1051	1146	1236	1261	1309	1424	1473	1665
Total power input for cooling	(1)(2)	kW	359	380	418	414	430	471	505	545	557	669
EER	(1)		2,65	2,64	2,51	2,77	2,87	2,68	2,59	2,61	2,65	2,49
ESEER			3,71	3,76	3,68	3,84	4,09	3,82	3,76	3,75	3,74	3,64
Efficiency class			D	D	D	C	C	D	D	D	D	E
Cooling (EN 14511 values)												
Nominal cooling capacity	(1)(8)	kW	948	997	1049	1143	1233	1258	1305	1420	1470	1660
EER	(1)(8)		2,61	2,60	2,50	2,74	2,84	2,65	2,56	2,59	2,62	2,46
ESEER	(8)		3,50	3,52	3,54	3,67	3,89	3,63	3,56	3,57	3,56	3,42
Efficiency class			D	D	E	C	C	D	D	D	D	E
Heating (Gross values)												
Nominal heating capacity	(3)	kW	-	-	-	-	-	-	-	-	-	-
Total power input for heating	(2)(3)	kW	-	-	-	-	-	-	-	-	-	-
COP	(3)		-	-	-	-	-	-	-	-	-	-
Efficiency class			-	-	-	-	-	-	-	-	-	-
Heating (EN 14511 values)												
Nominal heating capacity	(3)(8)	kW	-	-	-	-	-	-	-	-	-	-
COP	(3)(8)		-	-	-	-	-	-	-	-	-	-
Efficiency class			-	-	-	-	-	-	-	-	-	-
Compressors												
Type												
Quantity/Cooling circuits			Screw									
Partialisation steps	n°/n°		2 / 2	2 / 2	2 / 2	2 / 2	2 / 2	2 / 2	2 / 2	4 / 4	4 / 4	4 / 4
Total oil load	kg		56	56	56	56	50	50	50	80	92	112
Total cooling load (version CH)	kg		173	185	187	188	196	219	242	246	288	295
Total cooling load (version HP)	kg		-	-	-	-	-	-	-	-	-	-
Fans												
Type			Axials									
Quantity	n°		12	14	14	16	16	16	16	20	20	20
Air flow rate	m ³ /h		188.000	220.000	220.000	258.000	258.000	258.000	258.000	315.000	315.000	315.000
Evaporators												
Type			Shell and tube									
Quantity	n°		1	1	1	1	1	1	1	2	2	2
KAPPA V EVO water flow rate	l/h		163.543	172.197	180.748	197.012	212.554	216.853	225.107	244.798	253.388	286.328
KAPPA V EVO pressure drop	(6)	kPa	46	56	27	31	37	39	41	35	36	49
	(7)	kPa	-	-	-	-	-	-	-	-	-	-
Hydraulic module												
Useful static pressure	(9)	kPa	237	209	225	209	185	212	201	189	172	214
Storage tank capacity	(9)	l	900	900	900	900	900	900	900	-	-	-
Expansion tank		l	25	25	25	25	25	25	25	25	25	25
Noise												
Sound power level (SLN version)	(4)	dB(A)	90	91	91	91	92	92	92	92	92	93
Sound pressure level (SLN version)	(5)	dB(A)	57	58	58	58	59	59	59	59	59	60
Dimensions and base unit weights												
Length		mm	6.761	7.761	7.761	9.261	9.261	9.261	9.261	11.143	11.143	11.143
Depth		mm	2.315	2.315	2.315	2.315	2.315	2.315	2.315	2.315	2.315	2.315
Height		mm	2.402	2.402	2.402	2.402	2.402	2.402	2.402	2.402	2.402	2.402
Weight when functioning		kg	6.824	7.431	7.491	8.329	8.896	9.104	9.248	11.384	11.980	12.412

(1) External air temperature 35°C; input water-evaporator output temperature 12-7°C

(2) The total power is given by the sum of the power absorbed by the compressors and by the fans

(3) External air temperature 7°C DB, 6°C WB; condenser input-output temperature 40-45°C

(4) Sound power levels calculated compliant to ISO 3744

(5) Sound pressure levels refer to 10 meters from unit in free field and directionality factor Q=2

(6) Evaporator inlet-outlet water temperature 12-7°C

(7) Condenser inlet-outlet water temperature 40-45°C

(8) Values in compliance with EN 14511-3:2011

(9) In ST 2PS version

This board reports the feature data of the base and standard versions; for details, refer to the specific documentation.

TECHNICAL DATA KAPPA V EVO /A

UNIT SIZE			23.1	23.2	25.1	25.2	28.1	28.2	31.1	31.2	33.2	35.2	37.2
Cooling (Gross values)													
Nominal cooling capacity	(1)	kW	249	242	282	288	309	310	334	335	361	392	422
Total power input for cooling	(1)(2)	kW	77	74	89	91	94	97	104	106	111	122	130
EER	(1)		3,22	3,27	3,17	3,16	3,28	3,21	3,21	3,18	3,27	3,23	3,25
ESEER			4,05	4,13	4,01	4,02	4,09	4,08	4,02	3,99	4,13	4,10	4,11
Efficiency class			A	A	A	A	A	A	A	A	A	A	A
Cooling (EN 14511 values)													
Nominal cooling capacity	(1)(8)	kW	248	241	281	287	308	309	333	334	360	390	420
EER	(1)(8)		3,18	3,20	3,12	3,11	3,23	3,17	3,16	3,13	3,21	3,17	3,19
ESEER	(8)		3,82	3,82	3,73	3,75	3,84	3,83	3,76	3,74	3,86	3,80	3,80
Efficiency class			A	A	A	A	A	A	A	A	A	A	A
Heating (Gross values)													
Nominal heating capacity	(3)	kW	248	234	281	284	312	313	334	335	364	384	400
Total power input for heating	(2)(3)	kW	71	68	79	81	91	91	95	98	104	114	119
COP	(3)		3,51	3,43	3,54	3,50	3,45	3,42	3,51	3,44	3,52	3,37	3,36
Efficiency class			A	A	A	A	A	A	A	A	A	A	A
Heating (EN 14511 values)													
Nominal heating capacity	(3)(8)	kW	249	235	282	285	313	314	336	337	366	386	402
COP	(3)(8)		3,48	3,39	3,50	3,46	3,42	3,39	3,47	3,41	3,48	3,33	3,32
Efficiency class			A	A	A	A	A	A	A	A	A	A	A
Compressors													
Type													
Quantity/Cooling circuits		n°/n°	1 / 1	2 / 2	1 / 1	2 / 2	1 / 1	2 / 2	1 / 1	2 / 2	2 / 2	2 / 2	2 / 2
Partialisation steps		n°/n°											
Total oil load		kg	15	16	18	28	20	28	23	30	32	32	32
Total cooling load (version CH)		kg	35	38	36	40	40	42	42	45	60	63	65
Total cooling load (version HP)		kg	37	40	38	42	42	44	44	47	63	66	68
Fans													
Type													
Quantity		n°	4	4	4	4	6	6	6	6	6	8	8
Air flow rate		m ³ /h	86.000	86.000	86.000	86.000	140.000	140.000	140.000	140.000	134.000	182.000	182.000
Evaporators													
Type													
Quantity		n°	1	1	1	1	1	1	1	1	1	1	1
KAPPA V EVO water flow rate		l/h	42.837	41.617	48.576	49.527	53.153	53.310	57.438	57.610	62.081	67.442	72.571
KAPPA V EVO pressure drop	(6)	kPa	34	57	49	47	40	40	44	43	46	56	60
	(7)	kPa	39	60	58	55	47	47	53	51	54	60	64
Hydraulic module													
Useful static pressure	(9)	kPa	211	193	203	197	194	194	178	179	189	157	228
Storage tank capacity	(9)	l	585	-	585	-	585	-	585	-	-	740	740
Expansion tank		l	25	25	25	25	25	25	25	25	25	25	25
Noise													
Sound power level (basic unit)	(4)	dB(A)	92	92	92	92	93	93	94	94	94	95	96
Sound pressure level (basic unit)	(5)	dB(A)	60	60	60	60	61	61	62	62	62	63	64
Sound power level (LN version)	(4)	dB(A)	87	86	87	87	87	87	88	88	89	89	89
Sound pressure level (LN version)	(5)	dB(A)	55	54	55	55	55	55	56	56	57	57	57
Dimensions and base unit weights													
Length		mm	3.246	3.246	3.246	3.246	4.263	4.263	4.263	4.263	4.263	4.761	4.761
Depth		mm	2.315	2.315	2.315	2.315	2.315	2.315	2.315	2.315	2.315	2.315	2.315
Height		mm	2.402	2.402	2.402	2.402	2.402	2.402	2.402	2.402	2.402	2.402	2.402
Weight when functioning		kg	2.580	2.710	2.640	2.960	2.860	3.190	3.050	3.400	3.610	3.790	3.860

(1) External air temperature 35°C; input water-evaporator output temperature 12-7°C

(2) The total power is given by the sum of the power absorbed by the compressors and by the fans

(3) External air temperature 7°C DB, 6°C WB; condenser input-output temperature 40-45°C

(4) Sound power levels calculated compliant to ISO 3744

(5) Sound pressure levels refer to 10 meters from unit in free field and directionality factor Q=2

(6) Evaporator inlet-outlet water temperature 12-7°C

(7) Condenser inlet-outlet water temperature 40-45°C

(8) Values in compliance with EN 14511-3:2011

(9) In ST 2PS version

This board reports the feature data of the base and standard versions; for details, refer to the specific documentation.

TECHNICAL DATA KAPPA V EVO /A

UNIT SIZE			40.2	43.2	47.2	51.2	54.2	61.2	70.2	73.2	80.2	82.2	85.2
Cooling (Gross values)													
Nominal cooling capacity	(1)	kW	455	485	529	561	607	651	716	763	809	834	886
Total power input for cooling	(1)(2)	kW	145	147	167	172	192	197	223	233	253	251	276
EER	(1)		3,15	3,29	3,18	3,27	3,16	3,31	3,21	3,27	3,20	3,32	3,21
ESEER			4,02	4,08	4,01	4,09	4,19	4,28	4,21	4,10	4,15	4,20	4,16
Efficiency class			A	A	A	A	A	A	A	A	A	A	A
Cooling (EN 14511 values)													
Nominal cooling capacity	(1)(8)	kW	454	483	527	559	605	649	714	760	806	832	883
EER	(1)(8)		3,10	3,24	3,13	3,22	3,11	3,28	3,17	3,23	3,15	3,28	3,17
ESEER	(8)		3,76	3,81	3,75	3,82	3,89	4,05	3,95	3,83	3,86	3,96	3,91
Efficiency class			A	A	A	A	A	A	A	A	A	A	A
Heating (Gross values)													
Nominal heating capacity	(3)	kW	433	469	517	543	591	617	717	728	774	-	-
Total power input for heating	(2)(3)	kW	128	135	153	160	174	182	207	211	222	-	-
COP	(3)		3,38	3,47	3,39	3,40	3,41	3,40	3,47	3,45	3,49	-	-
Efficiency class			A	A	A	A	A	A	A	A	A	-	-
Heating (EN 14511 values)													
Nominal heating capacity	(3)(8)	kW	434	471	519	545	594	618	720	730	778	-	-
COP	(3)(8)		3,35	3,44	3,36	3,37	3,37	3,38	3,44	3,42	3,45	-	-
Efficiency class			A	A	A	A	A	A	A	A	A	-	-
Compressors													
Type													
Quantity/Cooling circuits		n°/n°	2 / 2	2 / 2	2 / 2	2 / 2	2 / 2	2 / 2	2 / 2	2 / 2	2 / 2	2 / 2	2 / 2
Partialisation steps		n°/n°											
Total oil load		kg	32	31	33	36	40	38	46	43	46	46	51
Total cooling load (version CH)		kg	69	73	73	73	95	117	122	128	144	139	141
Total cooling load (version HP)		kg	72	77	77	77	99	122	128	134	151	-	-
Fans													
Type													
Quantity		n°	8	8	10	10	10	10	12	12	12	12	12
Air flow rate		m ³ /h	182.000	174.800	227.000	218.000	218.000	212.000	262.000	262.000	262.000	252.000	252.000
Evaporators													
Type													
Quantity		n°	1	1	1	1	1	1	1	1	1	1	1
KAPPA V EVO water flow rate		l/h	78.304	83.405	90.972	96.475	104.385	111.952	123.130	131.212	139.123	143.422	152.365
KAPPA V EVO pressure drop	(6)	kPa	43	47	43	47	53	32	40	46	52	36	38
	(7)	kPa	45	52	48	51	59	33	44	48	55	-	-
Hydraulic module													
Useful static pressure	(9)	kPa	220	197	224	212	194	199	178	165	207	216	202
Storage tank capacity	(9)	l	740	740	740	740	740	740	900	900	900	900	900
Expansion tank		l	25	25	25	25	25	25	25	25	25	25	25
Noise													
Sound power level (basic unit)	(4)	dB(A)	96	96	98	97	98	99	100	100	100	100	100
Sound pressure level (basic unit)	(5)	dB(A)	64	64	66	65	66	66	68	68	68	67	67
Sound power level (LN version)	(4)	dB(A)	90	90	91	91	92	92	93	94	94	94	94
Sound pressure level (LN version)	(5)	dB(A)	58	58	59	59	60	60	61	62	62	62	62
Dimensions and base unit weights													
Length		mm	4.761	4.761	5.761	5.761	5.761	5.761	6.761	6.761	6.761	6.761	6.761
Depth		mm	2.315	2.315	2.315	2.315	2.315	2.315	2.315	2.315	2.315	2.315	2.315
Height		mm	2.402	2.402	2.402	2.402	2.402	2.402	2.402	2.402	2.402	2.402	2.402
Weight when functioning		kg	3.900	4.050	4.420	4.590	4.520	5.220	5.400	5.380	5.470	6.050	6.250

(1) External air temperature 35°C; input water-evaporator output temperature 12-7°C

(2) The total power is given by the sum of the power absorbed by the compressors and by the fans

(3) External air temperature 7°C DB, 6°C WB; condenser input-output temperature 40-45°C

(4) Sound power levels calculated compliant to ISO 3744

(5) Sound pressure levels refer to 10 meters from unit in free field and directionality factor Q=2

(6) Evaporator inlet-outlet water temperature 12-7°C

(7) Condenser inlet-outlet water temperature 40-45°C

(8) Values in compliance with EN 14511-3:2011

(9) In ST 2PS version

This board reports the feature data of the base and standard versions; for details, refer to the specific documentation.

TECHNICAL DATA KAPPA V EVO /A

UNIT SIZE			90.2	95.2	100.2	105.2	115.2	120.2	130.2	140.2	150.4
Cooling (Gross values)											
Nominal cooling capacity	(1)	kW	947	1004	1065	1132	1240	1374	1419	1461	1566
Total power input for cooling	(1)(2)	kW	296	308	331	342	388	437	445	453	496
EER	(1)		3,20	3,27	3,22	3,31	3,20	3,14	3,19	3,23	3,16
ESEER			4,01	4,15	4,10	4,17	4,21	4,20	4,06	4,10	4,02
Efficiency class			A	A	A	A	A	A	A	A	A
Cooling (EN 14511 values)											
Nominal cooling capacity	(1)(8)	kW	944	1001	1063	1128	1237	1370	1415	1456	1561
EER	(1)(8)		3,16	3,22	3,19	3,26	3,16	3,11	3,15	3,18	3,12
ESEER	(8)		3,76	3,87	3,89	3,88	3,96	3,94	3,80	3,83	3,75
Efficiency class			A	A	A	A	A	A	A	A	A
Heating (Gross values)											
Nominal heating capacity	(3)	kW	-	-	-	-	-	-	-	-	-
Total power input for heating	(2)(3)	kW	-	-	-	-	-	-	-	-	-
COP	(3)		-	-	-	-	-	-	-	-	-
Efficiency class			-	-	-	-	-	-	-	-	-
Heating (EN 14511 values)											
Nominal heating capacity	(3)(8)	kW	-	-	-	-	-	-	-	-	-
COP	(3)(8)		-	-	-	-	-	-	-	-	-
Efficiency class			-	-	-	-	-	-	-	-	-
Compressors											
Type			Screw								
Quantity/Cooling circuits		n°/n°	2 / 2	2 / 2	2 / 2	2 / 2	2 / 2	2 / 2	2 / 2	2 / 2	4 / 4
Partialisation steps		n°/n°	Continue								
Total oil load		kg	56	56	56	56	56	50	50	50	80
Total cooling load (version CH)		kg	141	159	173	185	188	196	219	242	246
Total cooling load (version HP)		kg	-	-	-	-	-	-	-	-	-
Fans											
Type			Axials								
Quantity		n°	14	14	14	16	16	20	20	20	20
Air flow rate		m3/h	296.000	288.000	288.000	354.000	342.000	436.000	424.000	412.000	412.000
Evaporators											
Type			Shell and tube								
Quantity		n°	1	1	1	1	1	1	1	1	2
KAPPA V EVO water flow rate		l/h	162.855	172.657	183.147	194.669	213.242	236.285	244.024	251.247	269.304
KAPPA V EVO pressure drop	(6)	kPa	42	47	28	51	38	42	44	46	47
	(7)	kPa	-	-	-	-	-	-	-	-	-
Hydraulic module											
Useful static pressure	(9)	kPa	209	192	194	214	176	205	197	189	207
Storage tank capacity	(9)	l	900	900	900	900	900	900	900	900	-
Expansion tank		l	25	25	25	25	25	25	25	25	25
Noise											
Sound power level (basic unit)	(4)	dB(A)	101	101	101	102	103	103	104	104	104
Sound pressure level (basic unit)	(5)	dB(A)	69	69	69	70	71	71	72	72	72
Sound power level (LN version)	(4)	dB(A)	95	95	95	96	96	97	97	97	97
Sound pressure level (LN version)	(5)	dB(A)	63	63	63	64	64	65	65	65	65
Dimensions and base unit weights											
Length		mm	7.761	7.761	7.761	9.261	9.261	11.483	11.483	11.483	11.483
Depth		mm	2.315	2.315	2.315	2.315	2.315	2.315	2.315	2.315	2.315
Height		mm	2.402	2.402	2.402	2.402	2.402	2.402	2.402	2.402	2.402
Weight when functioning		kg	7.010	7.120	7.190	7.650	7.750	9.610	9.690	10.150	10.710

(1) External air temperature 35°C; input water-evaporator output temperature 12-7°C

(2) The total power is given by the sum of the power absorbed by the compressors and by the fans

(3) External air temperature 7°C DB, 6°C WB; condenser input-output temperature 40-45°C

(4) Sound power levels calculated compliant to ISO 3744

(5) Sound pressure levels refer to 10 meters from unit in free field and directionality factor Q=2

(6) Evaporator inlet-outlet water temperature 12-7°C

(7) Condenser inlet-outlet water temperature 40-45°C

(8) Values in compliance with EN 14511-3:2011

(9) In ST 2PS version

This board reports the feature data of the base and standard versions; for details, refer to the specific documentation.

TECHNICAL DATA KAPPA V EVO /A SLN

UNIT SIZE			23.1	23.2	25.1	25.2	28.1	28.2	31.1	31.2	33.2	35.2	37.2
Cooling (Gross values)													
Nominal cooling capacity	(1)	kW	242	234	276	277	299	302	324	325	351	382	409
Total power input for cooling	(1)(2)	kW	78	75	90	92	95	98	105	107	112	123	132
EER	(1)		3,09	3,13	3,07	3,02	3,14	3,08	3,09	3,04	3,13	3,12	3,11
ESEER			4,10	4,17	4,02	4,05	4,15	4,10	4,06	4,00	4,14	4,15	4,16
Efficiency class			B	A	B	B	A	B	B	B	A	A	A
Cooling (EN 14511 values)													
Nominal cooling capacity	(1)(8)	kW	241	233	275	276	298	301	323	324	350	380	407
EER	(1)(8)		3,05	3,07	3,02	2,97	3,10	3,03	3,05	2,99	3,08	3,06	3,05
ESEER	(8)		3,87	3,86	3,74	3,78	3,90	3,85	3,80	3,74	3,87	3,84	3,84
Efficiency class			B	B	B	B	B	B	B	B	B	B	B
Heating (Gross values)													
Nominal heating capacity	(3)	kW	237	229	273	267	307	309	327	328	348	377	393
Total power input for heating	(2)(3)	kW	68	66	76	77	86	88	92	93	98	109	114
COP	(3)		3,50	3,48	3,60	3,47	3,56	3,51	3,55	3,51	3,54	3,47	3,45
Efficiency class			A	A	A	A	A	A	A	A	A	A	A
Heating (EN 14511 values)													
Nominal heating capacity	(3)(8)	kW	238	230	274	268	308	310	329	329	349	379	395
COP	(3)(8)		3,47	3,44	3,56	3,44	3,53	3,48	3,51	3,47	3,51	3,43	3,41
Efficiency class			A	A	A	A	A	A	A	A	A	A	A
Compressors													
Type			Screw										
Quantity/Cooling circuits		n°/n°	1 / 1	2 / 2	1 / 1	2 / 2	1 / 1	2 / 2	1 / 1	2 / 2	2 / 2	2 / 2	2 / 2
Partialisation steps		n°/n°	Continue										
Total oil load		kg	15	16	18	28	20	28	23	30	32	32	32
Total cooling load (version CH)		kg	35	38	36	40	40	42	42	45	60	63	65
Total cooling load (version HP)		kg	37	40	38	42	42	44	44	47	63	66	68
Fans													
Type			Axials										
Quantity		n°	4	4	4	4	6	6	6	6	6	8	8
Air flow rate		m ³ /h	71.200	71.200	69.200	69.200	108.000	108.000	108.000	108.000	106.000	140.000	140.000
Evaporators													
Type			Shell and tube										
Quantity		n°	1	1	1	1	1	1	1	1	1	1	1
KAPPA V EVO water flow rate		l/h	41.617	40.241	47.463	47.635	51.419	51.935	55.718	55.890	60.361	65.692	70.335
KAPPA V EVO pressure drop	(6)	kPa	33	55	48	46	38	40	43	42	45	54	58
	(7)	kPa	36	58	54	49	46	46	50	49	49	58	62
Hydraulic module													
Useful static pressure	(9)	kPa	211	193	203	197	194	194	178	179	189	157	228
Storage tank capacity	(9)	l	585	-	585	-	585	-	585	-	-	740	740
Expansion tank		l	25	25	25	25	25	25	25	25	25	25	25
Noise													
Sound power level (SLN version)	(4)	dB(A)	82	82	82	82	83	82	83	83	83	83	84
Sound pressure level (SLN version)	(5)	dB(A)	50	50	50	50	51	50	51	51	51	51	52
Dimensions and base unit weights													
Length		mm	3.246	3.246	3.246	3.246	4.263	4.263	4.263	4.263	4.263	4.761	4.761
Depth		mm	2.315	2.315	2.315	2.315	2.315	2.315	2.315	2.315	2.315	2.315	2.315
Height		mm	2.402	2.402	2.402	2.402	2.402	2.402	2.402	2.402	2.402	2.402	2.402
Weight when functioning		kg	2.810	3.160	2.970	3.510	3.090	3.800	3.280	3.850	4.060	4.240	4.310

(1) External air temperature 35°C; input water-evaporator output temperature 12-7°C

(2) The total power is given by the sum of the power absorbed by the compressors and by the fans

(3) External air temperature 7°C DB, 6°C WB; condenser input-output temperature 40-45°C

(4) Sound power levels calculated compliant to ISO 3744

(5) Sound pressure levels refer to 10 meters from unit in free field and directionality factor Q=2

(6) Evaporator inlet-outlet water temperature 12-7°C

(7) Condenser inlet-outlet water temperature 40-45°C

(8) Values in compliance with EN 14511-3:2011

(9) In ST 2PS version

This board reports the feature data of the base and standard versions; for details, refer to the specific documentation.

TECHNICAL DATA KAPPA V EVO /A SLN

UNIT SIZE			40.2	43.2	47.2	51.2	54.2	61.2	70.2	73.2	80.2	85.2	90.2
Cooling (Gross values)													
Nominal cooling capacity	(1)	kW	452	469	514	545	589	634	701	744	796	875	922
Total power input for cooling	(1)(2)	kW	142	152	169	174	199	209	234	245	260	281	312
EER	(1)		3,19	3,09	3,04	3,13	2,96	3,04	2,99	3,04	3,06	3,11	2,96
ESEER			4,08	4,10	4,05	4,11	4,25	4,29	4,26	4,14	4,16	4,17	4,05
Efficiency class			A	B	B	A	B	B	B	B	B	A	B
Cooling (EN 14511 values)													
Nominal cooling capacity	(1)(8)	kW	450	467	512	543	587	632	699	742	793	873	919
EER	(1)(8)		3,15	3,05	2,99	3,09	2,91	2,99	2,96	3,00	3,01	3,07	2,92
ESEER	(8)		3,82	3,82	3,79	3,83	3,95	4,06	4,00	3,87	3,86	3,92	3,79
Efficiency class			A	B	B	B	B	B	B	B	B	B	B
Heating (Gross values)													
Nominal heating capacity	(3)	kW	444	458	507	519	563	588	681	706	737	-	-
Total power input for heating	(2)(3)	kW	124	130	146	152	165	173	196	202	212	-	-
COP	(3)		3,60	3,53	3,47	3,41	3,41	3,40	3,47	3,49	3,47	-	-
Efficiency class			A	A	A	A	A	A	A	A	A	-	-
Heating (EN 14511 values)													
Nominal heating capacity	(3)(8)	kW	446	460	509	521	565	589	683	709	740	-	-
COP	(3)(8)		3,56	3,50	3,44	3,38	3,38	3,38	3,44	3,46	3,44	-	-
Efficiency class			A	A	A	A	A	A	A	A	A	-	-
Compressors													
Type													
Quantity/Cooling circuits		n°/n°	2 / 2	2 / 2	2 / 2	2 / 2	2 / 2	2 / 2	2 / 2	2 / 2	2 / 2	2 / 2	2 / 2
Partialisation steps		n°/n°											
Total oil load		kg	32	31	33	36	40	38	46	43	46	51	56
Total cooling load (version CH)		kg	69	73	73	73	95	117	122	128	144	141	141
Total cooling load (version HP)		kg	72	77	77	77	99	122	128	134	151	-	-
Fans													
Type													
Quantity		n°	8	8	10	10	10	10	12	12	12	14	14
Air flow rate		m ³ /h	136.000	136.000	178.000	168.000	168.000	160.000	200.000	200.000	192.000	238.000	238.000
Evaporators													
Type													
Quantity		n°	1	1	1	1	1	1	1	1	1	1	1
KAPPA V EVO water flow rate		l/h	77.730	80.653	88.392	93.723	101.290	109.028	120.550	127.945	136.887	150.473	158.555
KAPPA V EVO pressure drop	(6)	kPa	42	46	53	45	51	51	39	43	50	38	41
	(7)	kPa	48	50	46	47	54	30	40	46	50	-	-
Hydraulic module													
Useful static pressure	(9)	kPa	220	197	224	212	194	199	178	165	207	202	209
Storage tank capacity	(9)	l	740	740	740	740	740	740	900	900	900	900	900
Expansion tank		l	25	25	25	25	25	25	25	25	25	25	25
Noise													
Sound power level (SLN version)	(4)	dB(A)	85	85	86	85	86	86	87	88	88	89	90
Sound pressure level (SLN version)	(5)	dB(A)	53	53	54	53	54	54	55	56	56	57	58
Dimensions and base unit weights													
Length		mm	4.761	4.761	5.761	5.761	5.761	5.761	6.761	6.761	6.761	7.761	7.761
Depth		mm	2.315	2.315	2.315	2.315	2.315	2.315	2.315	2.315	2.315	2.315	2.315
Height		mm	2.402	2.402	2.402	2.402	2.402	2.402	2.402	2.402	2.402	2.402	2.402
Weight when functioning		kg	4.500	4.500	4.870	5.040	4.970	5.670	5.850	5.830	6.120	7.320	7.510

(1) External air temperature 35°C; input water-evaporator output temperature 12-7°C

(2) The total power is given by the sum of the power absorbed by the compressors and by the fans

(3) External air temperature 7°C DB, 6°C WB; condenser input-output temperature 40-45°C

(4) Sound power levels calculated compliant to ISO 3744

(5) Sound pressure levels refer to 10 meters from unit in free field and directionality factor Q=2

(6) Evaporator inlet-outlet water temperature 12-7°C

(7) Condenser inlet-outlet water temperature 40-45°C

(8) Values in compliance with EN 14511-3:2011

(9) In ST 2PS version

This board reports the feature data of the base and standard versions; for details, refer to the specific documentation.

TECHNICAL DATA KAPPA V EVO /A SLN

UNIT SIZE			95.2	100.2	105.2	115.2	120.2	130.2	140.2
Cooling (Gross values)									
Nominal cooling capacity	(1)	kW	982	1040	1104	1211	1351	1382	1410
Total power input for cooling	(1),(2)	kW	324	338	363	406	444	461	478
EER	(1)		3,03	3,08	3,04	2,98	3,04	3,00	2,95
ESEER			4,15	4,15	4,20	4,25	4,28	4,11	4,12
Efficiency class			B	B	B	B	B	B	B
Cooling (EN 14511 values)									
Nominal cooling capacity	(1),(8)	kW	979	1036	1100	1208	1347	1378	1406
EER	(1),(8)		2,99	3,02	3,00	2,95	3,01	2,96	2,91
ESEER	(8)		3,87	3,94	3,91	4,00	4,01	3,84	3,85
Efficiency class			B	B	B	B	B	B	B
Heating (Gross values)									
Nominal heating capacity	(3)	kW	-	-	-	-	-	-	-
Total power input for heating	(2),(3)	kW	-	-	-	-	-	-	-
COP	(3)		-	-	-	-	-	-	-
Efficiency class			-	-	-	-	-	-	-
Heating (EN 14511 values)									
Nominal heating capacity	(3),(8)	kW	-	-	-	-	-	-	-
COP	(3),(8)		-	-	-	-	-	-	-
Efficiency class			-	-	-	-	-	-	-
Compressors									
Type						Screw			
Quantity/Cooling circuits		n°/n°	2 / 2	2 / 2	2 / 2	2 / 2	2 / 2	2 / 2	2 / 2
Partialisation steps		n°/n°				Continue			
Total oil load		kg	56	56	56	56	50	50	50
Total cooling load (version CH)		kg	159	173	185	188	196	219	242
Total cooling load (version HP)		kg	-	-	-	-	-	-	-
Fans									
Type						Axials			
Quantity		n°	14	16	16	16	20	20	20
Air flow rate		m3/h	228.000	276.000	276.000	264.000	320.000	320.000	320.000
Evaporators									
Type						Shell and tube			
Quantity		n°	1	1	1	1	1	1	1
KAPPA V EVO water flow rate		l/h	168.874	178.848	189.854	208.255	232.330	237.661	242.476
KAPPA V EVO pressure drop	(6)	kPa	46	60	50	35	41	43	44
	(7)	kPa	-	-	-	-	-	-	-
Hydraulic module									
Useful static pressure	(9)	kPa	192	194	214	176	205	197	189
Storage tank capacity	(9)	l	900	900	900	900	900	900	900
Expansion tank		l	25	25	25	25	25	25	25
Noise									
Sound power level (SLN version)	(4)	dB(A)	90	90	91	91	92	92	92
Sound pressure level (SLN version)	(5)	dB(A)	58	58	59	59	60	60	59
Dimensions and base unit weights									
Length		mm	7.761	9.261	9.261	9.261	11.483	11.483	11.483
Depth		mm	2.315	2.315	2.315	2.315	2.315	2.315	2.315
Height		mm	2.402	2.402	2.402	2.402	2.402	2.402	2.402
Weight when functioning		kg	7.620	8.150	8.280	8.380	10.360	10.500	10.650

(1) External air temperature 35°C; input water-evaporator output temperature 12-7°C

(2) The total power is given by the sum of the power absorbed by the compressors and by the fans

(3) External air temperature 7°C DB, 6°C WB; condenser input-output temperature 40-45°C

(4) Sound power levels calculated compliant to ISO 3744

(5) Sound pressure levels refer to 10 meters from unit in free field and directionality factor Q=2

(6) Evaporator inlet-outlet water temperature 12-7°C

(7) Condenser inlet-outlet water temperature 40-45°C

(8) Values in compliance with EN 14511-3:2011

(9) In ST 2PS version

This board reports the feature data of the base and standard versions; for details, refer to the specific documentation.

ELECTRICAL DATA KAPPA V EVO

UNIT SIZE			23.1	25.1	28.1	31.1	33.2	35.2	37.2	40.2	43.2	47.2	51.2
Maximum absorbed power	(1),(3)	kW	108 (112)	120 (125)	131 (137)	141 (146)	156 (162)	167 (173)	177 (182)	190 (197)	205 (214)	228 (237)	240 (249)
Maximum absorbed current	(2),(3)	A	181 (189)	201 (212)	219 (230)	235 (246)	262 (273)	280 (291)	296 (307)	317 (333)	344 (363)	382 (401)	401 (420)
Maximum current at peak	(4)	A	247 (251)	299 (305)	299 (305)	322 (328)	352 (357)	361 (366)	401 (406)	412 (419)	420 (429)	480 (489)	500 (509)
Fan nominal power		r _f x kW	4 x 2,0	4 x 2,0	4 x 2,0	4 x 2,0	6 x 2,0	6 x 2,0	6 x 2,0	6 x 2,0	8 x 2,0	8 x 2,0	8 x 2,0
Fan nominal current		r _f x A	4 x 4,3	4 x 4,3	4 x 4,3	4 x 4,3	6 x 4,3	6 x 4,3	6 x 4,3	6 x 4,3	8 x 4,3	8 x 4,3	8 x 4,3
Pump motor nominal power		kW	4	6	6	6	6	6	6	8	9	9	9
Pump motor nominal current		A	8	11	11	11	11	11	11	16	19	19	19
Electric power supply		V _{ph} /Hz	400/3-50±5%	400/3-50±5%	400/3-50±5%	400/3-50±5%	400/3-50±5%	400/3-50±5%	400/3-50±5%	400/3-50±5%	400/3-50±5%	400/3-50±5%	400/3-50±5%
Auxiliary power supply		V _{ph} /Hz	230/1-50±5%	230/1-50±5%	230/1-50±5%	230/1-50±5%	230/1-50±5%	230/1-50±5%	230/1-50±5%	230/1-50±5%	230/1-50±5%	230/1-50±5%	230/1-50±5%

UNIT SIZE			54.2	58.2	61.2	67.2	70.2	73.2	80.2	82.2	85.2	90.2	95.2
Maximum absorbed power	(1),(3)	kW	262 (271)	281 (291)	255 (264)	266 (277)	285 (296)	292 (303)	311 (326)	318 (333)	339 (354)	363 (378)	382 (400)
Maximum absorbed current	(2),(3)	A	438 (457)	470 (489)	428 (447)	446 (469)	478 (501)	490 (512)	520 (550)	535 (565)	568 (599)	608 (639)	639 (676)
Maximum current at peak	(4)	A	518 (527)	557 (566)	508 (518)	527 (538)	566 (577)	566 (577)	749 (764)	721 (736)	757 (772)	797 (812)	828 (846)
Fan nominal power		r _f x kW	8 x 2,0	8 x 2,0	10 x 2,0	10 x 2,0	10 x 2,0	10 x 2,0	10 x 2,0	12 x 2,0	12 x 2,0	12 x 2,0	12 x 2,0
Fan nominal current		r _f x A	8 x 4,3	8 x 4,3	10 x 4,3	10 x 4,3	10 x 4,3	10 x 4,3	10 x 4,3	12 x 4,3	12 x 4,3	12 x 4,3	12 x 4,3
Pump motor nominal power		kW	9	9	9	11	11	11	15	15	15	15	19
Pump motor nominal current		A	19	19	19	23	23	23	30	30	30	30	37
Electric power supply		V _{ph} /Hz	400/3-50±5%	400/3-50±5%	400/3-50±5%	400/3-50±5%	400/3-50±5%	400/3-50±5%	400/3-50±5%	400/3-50±5%	400/3-50±5%	400/3-50±5%	400/3-50±5%
Auxiliary power supply		V _{ph} /Hz	230/1-50±5%	230/1-50±5%	230/1-50±5%	230/1-50±5%	230/1-50±5%	230/1-50±5%	230/1-50±5%	230/1-50±5%	230/1-50±5%	230/1-50±5%	230/1-50±5%

UNIT SIZE			100.2	105.2	110.2	115.2	120.2	130.2	140.2	150.4	160.4	180.4
Maximum absorbed power	(1),(3)	kW	400 (419)	421 (439)	465 (487)	469 (491)	498 (520)	516 (538)	534 (556)	599 (621)	622 (644)	718 (748)
Maximum absorbed current	(2),(3)	A	669 (706)	704 (741)	778 (819)	786 (828)	823 (865)	855 (897)	887 (929)	1002 (1.044)	1040 (1.082)	1199 (1.253)
Maximum current at peak	(4)	A	858 (877)	927 (946)	1112 (1.134)	1121 (1.143)	1251 (1.273)	1363 (1.385)	1395 (1.417)	1078 (1.100)	1269 (1.291)	1388 (1.418)
Fan nominal power		r _f x kW	12 x 2,0	14 x 2,0	14 x 2,0	16 x 2,0	16 x 2,0	16 x 2,0	16 x 2,0	20 x 2,0	20 x 2,0	20 x 2,0
Fan nominal current		r _f x A	12 x 4,3	14 x 4,3	14 x 4,3	16 x 4,3	16 x 4,3	16 x 4,3	16 x 4,3	20 x 4,3	20 x 4,3	20 x 4,3
Pump motor nominal power		kW	19	19	22	22	22	22	22	22	22	30
Pump motor nominal current		A	37	37	42	42	42	42	42	42	42	54
Electric power supply		V _{ph} /Hz	400/3-50±5%	400/3-50±5%	400/3-50±5%	400/3-50±5%	400/3-50±5%	400/3-50±5%	400/3-50±5%	400/3-50±5%	400/3-50±5%	400/3-50±5%
Auxiliary power supply		V _{ph} /Hz	230/1-50±5%	230/1-50±5%	230/1-50±5%	230/1-50±5%	230/1-50±5%	230/1-50±5%	230/1-50±5%	230/1-50±5%	230/1-50±5%	230/1-50±5%

(1) Electric power which must be available from the electric network for the unit to function
 (2) It is the maximum current absorbed by the unit. This value is never exceeded and must be used for dimensioning the line and the relative protections (refer to the wiring diagram supplied with the units).
 (3) The values between brackets refer to the ST version units (unit with storage tank and pumps

or to units with pumps only).
 (4) Maximum peak current calculated considering the compressor start-up with higher power and maximum current absorbed by all other devices.
 This board reports the feature data of the base and standard versions; for details, refer to the specific documentation.

ELECTRICAL DATA KAPPA V EVO /SLN

UNIT SIZE			23.1	25.1	28.1	31.1	33.2	35.2	37.2	40.2	43.2	47.2	51.2
Maximum absorbed power	(1),(3)	kW	108 (112)	120 (125)	131 (137)	141 (146)	156 (162)	167 (173)	177 (182)	190 (197)	205 (214)	228 (237)	240 (249)
Maximum absorbed current	(2),(3)	A	181 (189)	201 (212)	219 (230)	235 (246)	262 (273)	280 (291)	296 (307)	317 (333)	344 (363)	382 (401)	401 (420)
Maximum current at peak	(4)	A	247 (251)	299 (305)	299 (305)	322 (328)	352 (357)	361 (366)	401 (406)	412 (419)	420 (429)	480 (489)	500 (509)
Fan nominal power		n ^r xkW	4 x 2,0	4 x 2,0	4 x 2,0	4 x 2,0	6 x 2,0	6 x 2,0	6 x 2,0	6 x 2,0	8 x 2,0	8 x 2,0	8 x 2,0
Fan nominal current		n ^r xA	4 x 4,3	4 x 4,3	4 x 4,3	4 x 4,3	6 x 4,3	6 x 4,3	6 x 4,3	6 x 4,3	8 x 4,3	8 x 4,3	8 x 4,3
Pump motor nominal power		kW	4	6	6	6	6	6	6	8	9	9	9
Pump motor nominal current		A	8	11	11	11	11	11	11	16	19	19	19
Electric power supply		V _{ph} /Hz	400/3-50±5%	400/3-50±5%	400/3-50±5%	400/3-50±5%	400/3-50±5%	400/3-50±5%	400/3-50±5%	400/3-50±5%	400/3-50±5%	400/3-50±5%	400/3-50±5%
Auxiliary power supply		V _{ph} /Hz	230/1-50±5%	230/1-50±5%	230/1-50±5%	230/1-50±5%	230/1-50±5%	230/1-50±5%	230/1-50±5%	230/1-50±5%	230/1-50±5%	230/1-50±5%	230/1-50±5%

UNIT SIZE			54.2	58.2	61.2	67.2	70.2	73.2	80.2	82.2	85.2	90.2	95.2
Maximum absorbed power	(1),(3)	kW	262 (271)	281 (291)	255 (264)	266 (277)	285 (296)	292 (303)	311 (326)	318 (333)	339 (354)	363 (378)	382 (400)
Maximum absorbed current	(2),(3)	A	438 (457)	470 (489)	428 (447)	446 (469)	478 (501)	490 (512)	520 (550)	535 (565)	568 (599)	608 (639)	639 (676)
Maximum current at peak	(4)	A	518 (527)	557 (566)	508 (518)	527 (538)	566 (577)	566 (577)	749 (764)	721 (736)	757 (772)	797 (812)	828 (846)
Fan nominal power		n ^r xkW	8 x 2,0	8 x 2,0	10 x 2,0	10 x 2,0	10 x 2,0	10 x 2,0	10 x 2,0	12 x 2,0	12 x 2,0	12 x 2,0	12 x 2,0
Fan nominal current		n ^r xA	8 x 4,3	8 x 4,3	10 x 4,3	10 x 4,3	10 x 4,3	10 x 4,3	10 x 4,3	12 x 4,3	12 x 4,3	12 x 4,3	12 x 4,3
Pump motor nominal power		kW	9	9	9	11	11	11	15	15	15	15	19
Pump motor nominal current		A	19	19	19	23	23	23	30	30	30	30	37
Electric power supply		V _{ph} /Hz	400/3-50±5%	400/3-50±5%	400/3-50±5%	400/3-50±5%	400/3-50±5%	400/3-50±5%	400/3-50±5%	400/3-50±5%	400/3-50±5%	400/3-50±5%	400/3-50±5%
Auxiliary power supply		V _{ph} /Hz	230/1-50±5%	230/1-50±5%	230/1-50±5%	230/1-50±5%	230/1-50±5%	230/1-50±5%	230/1-50±5%	230/1-50±5%	230/1-50±5%	230/1-50±5%	230/1-50±5%

UNIT SIZE			100.2	105.2	110.2	115.2	120.2	130.2	140.2	150.4	160.4	180.4
Maximum absorbed power	(1),(3)	kW	400 (419)	421 (439)	465 (487)	469 (491)	498 (520)	516 (538)	534 (556)	599 (621)	622 (644)	718 (748)
Maximum absorbed current	(2),(3)	A	669 (706)	704 (741)	778 (819)	786 (828)	823 (865)	855 (897)	887 (929)	1002 (1.044)	1040 (1.082)	1199 (1.253)
Maximum current at peak	(4)	A	858 (877)	927 (946)	1112 (1.134)	1121 (1.143)	1251 (1.273)	1363 (1.385)	1395 (1.417)	1078 (1.100)	1269 (1.291)	1388 (1.418)
Fan nominal power		n ^r xkW	12 x 2,0	14 x 2,0	14 x 2,0	16 x 2,0	16 x 2,0	16 x 2,0	16 x 2,0	20 x 2,0	20 x 2,0	20 x 2,0
Fan nominal current		n ^r xA	12 x 4,3	14 x 4,3	14 x 4,3	16 x 4,3	16 x 4,3	16 x 4,3	16 x 4,3	20 x 4,3	20 x 4,3	20 x 4,3
Pump motor nominal power		kW	19	19	22	22	22	22	22	22	22	30
Pump motor nominal current		A	37	37	42	42	42	42	42	42	42	54
Electric power supply		V _{ph} /Hz	400/3-50±5%	400/3-50±5%	400/3-50±5%	400/3-50±5%	400/3-50±5%	400/3-50±5%	400/3-50±5%	400/3-50±5%	400/3-50±5%	400/3-50±5%
Auxiliary power supply		V _{ph} /Hz	230/1-50±5%	230/1-50±5%	230/1-50±5%	230/1-50±5%	230/1-50±5%	230/1-50±5%	230/1-50±5%	230/1-50±5%	230/1-50±5%	230/1-50±5%

(1) Electric power which must be available from the electric network for the unit to function
 (2) It is the maximum current absorbed by the unit. This value is never exceeded and must be used for dimensioning the line and the relative protections (refer to the wiring diagram supplied with the units).
 (3) The values between brackets refer to the ST version units (unit with storage tank and pumps

or to units with pumps only).
 (4) Maximum peak current calculated considering the compressor start-up with higher power and maximum current absorbed by all other devices.
 This board reports the feature data of the base and standard versions; for details, refer to the specific documentation.

ELECTRICAL DATA KAPPA V EVO /A

UNIT SIZE			23.1	23.2	25.1	25.2	28.1	28.2	31.1	31.2	33.2	35.2	37.2
Maximum absorbed power	(1),(3)	kW	108 (112)	104 (108)	120 (125)	122 (128)	135 (141)	138 (144)	145 (150)	147 (153)	156 (162)	171 (177)	181 (188)
Maximum absorbed current	(2),(3)	A	181 (189)	174 (183)	201 (212)	205 (217)	228 (239)	234 (245)	244 (255)	248 (259)	262 (273)	289 (300)	304 (320)
Maximum current at peak	(4)	A	247 (251)	204 (208)	299 (305)	278 (284)	308 (313)	297 (302)	331 (336)	338 (343)	352 (357)	370 (375)	409 (417)
Fan nominal power		n°xkW	4 x 2,0	4 x 2,0	4 x 2,0	4 x 2,0	6 x 2,0	6 x 2,0	6 x 2,0	6 x 2,0	6 x 2,0	8 x 2,0	8 x 2,0
Fan nominal current		n°xA	4 x 4,3	4 x 4,3	4 x 4,3	4 x 4,3	6 x 4,3	6 x 4,3	6 x 4,3	6 x 4,3	6 x 4,3	8 x 4,3	8 x 4,3
Pump motor nominal power		kW	4	4	6	6	6	6	6	6	6	6	8
Pump motor nominal current		A	8	8	11	11	11	11	11	11	11	11	16
Electric power supply		V _{ph} Hz	4003-50±5%	4003-50±5%	4003-50±5%	4003-50±5%	4003-50±5%	4003-50±5%	4003-50±5%	4003-50±5%	4003-50±5%	4003-50±5%	4003-50±5%
Auxiliary power supply		V _{ph} Hz	2301-50±5%	2301-50±5%	2301-50±5%	2301-50±5%	2301-50±5%	2301-50±5%	2301-50±5%	2301-50±5%	2301-50±5%	2301-50±5%	2301-50±5%

UNIT SIZE			40.2	43.2	47.2	51.2	54.2	61.2	70.2	73.2	80.2	82.2	85.2
Maximum absorbed power	(1),(3)	kW	194 (201)	205 (212)	232 (241)	244 (253)	266 (275)	255 (264)	289 (300)	296 (307)	315 (330)	318 (333)	339 (354)
Maximum absorbed current	(2),(3)	A	326 (342)	344 (360)	390 (409)	410 (429)	446 (465)	428 (447)	487 (510)	498 (521)	529 (559)	535 (565)	568 (599)
Maximum current at peak	(4)	A	420 (428)	420 (428)	489 (498)	508 (518)	527 (536)	508 (518)	574 (585)	574 (585)	757 (772)	721 (736)	757 (772)
Fan nominal power		n°xkW	8 x 2,0	8 x 2,0	10 x 2,0	10 x 2,0	10 x 2,0	10 x 2,0	12 x 2,0	12 x 2,0	12 x 2,0	12 x 2,0	12 x 2,0
Fan nominal current		n°xA	8 x 4,3	8 x 4,3	10 x 4,3	10 x 4,3	10 x 4,3	10 x 4,3	12 x 4,3	12 x 4,3	12 x 4,3	12 x 4,3	12 x 4,3
Pump motor nominal power		kW	8	8	9	9	9	9	11	11	15	15	15
Pump motor nominal current		A	16	16	19	19	19	19	23	23	30	30	30
Electric power supply		V _{ph} Hz	4003-50±5%	4003-50±5%	4003-50±5%	4003-50±5%	4003-50±5%	4003-50±5%	4003-50±5%	4003-50±5%	4003-50±5%	4003-50±5%	4003-50±5%
Auxiliary power supply		V _{ph} Hz	2301-50±5%	2301-50±5%	2301-50±5%	2301-50±5%	2301-50±5%	2301-50±5%	2301-50±5%	2301-50±5%	2301-50±5%	2301-50±5%	2301-50±5%

UNIT SIZE			90.2	95.2	100.2	105.2	115.2	120.2	130.2	140.2	150.4
Maximum absorbed power	(1),(3)	kW	367 (382)	386 (401)	404 (419)	425 (443)	469 (488)	506 (528)	524 (546)	542 (564)	599 (629)
Maximum absorbed current	(2),(3)	A	617 (647)	647 (678)	677 (708)	713 (750)	786 (823)	840 (882)	872 (914)	904 (946)	1002 (1056)
Maximum current at peak	(4)	A	806 (821)	837 (852)	867 (882)	936 (954)	1121 (1139)	1268 (1290)	1380 (1402)	1412 (1434)	1078 (1108)
Fan nominal power		n°xkW	14 x 2,0	14 x 2,0	14 x 2,0	16 x 2,0	16 x 2,0	20 x 2,0	20 x 2,0	20 x 2,0	20 x 2,0
Fan nominal current		n°xA	14 x 4,3	14 x 4,3	14 x 4,3	16 x 4,3	16 x 4,3	20 x 4,3	20 x 4,3	20 x 4,3	20 x 4,3
Pump motor nominal power		kW	15	15	15	19	19	22	22	22	30
Pump motor nominal current		A	30	30	30	37	37	42	42	42	54
Electric power supply		V _{ph} Hz	4003-50±5%	4003-50±5%	4003-50±5%	4003-50±5%	4003-50±5%	4003-50±5%	4003-50±5%	4003-50±5%	4003-50±5%
Auxiliary power supply		V _{ph} Hz	2301-50±5%	2301-50±5%	2301-50±5%	2301-50±5%	2301-50±5%	2301-50±5%	2301-50±5%	2301-50±5%	2301-50±5%

(1) Electric power which must be available from the electric network for the unit to function
 (2) It is the maximum current absorbed by the unit. This value is never exceeded and must be used for dimensioning the line and the relative protections (refer to the wiring diagram supplied with the units).
 (3) The values between brackets refer to the ST version units (unit with storage tank and pumps

or to units with pumps only).
 (4) Maximum peak current calculated considering the compressor start-up with higher power and maximum current absorbed by all other devices.
 This board reports the feature data of the base and standard versions; for details, refer to the specific documentation.

ELECTRICAL DATA KAPPA V EVO /A SLN

UNIT SIZE			23.1	23.2	25.1	25.2	28.1	28.2	31.1	31.2	33.2	35.2	37.2
Maximum absorbed power	(1),(3)	kW	108 (112)	104 (108)	120 (125)	122 (128)	135 (141)	138 (144)	145 (150)	147 (153)	156 (162)	171 (177)	181 (188)
Maximum absorbed current	(2),(3)	A	181 (189)	174 (183)	201 (212)	205 (217)	228 (239)	234 (245)	244 (255)	248 (259)	262 (273)	289 (300)	304 (320)
Maximum current at peak	(4)	A	247 (251)	204 (208)	299 (305)	278 (284)	308 (313)	297 (302)	331 (336)	338 (343)	352 (357)	370 (375)	409 (417)
Fan nominal power		rfxkW	4 x 2,0	4 x 2,0	4 x 2,0	4 x 2,0	6 x 2,0	6 x 2,0	6 x 2,0	6 x 2,0	6 x 2,0	8 x 2,0	8 x 2,0
Fan nominal current		rfxA	4 x 4,3	4 x 4,3	4 x 4,3	4 x 4,3	6 x 4,3	6 x 4,3	6 x 4,3	6 x 4,3	6 x 4,3	8 x 4,3	8 x 4,3
Pump motor nominal power		kW	4	4	6	6	6	6	6	6	6	6	8
Pump motor nominal current		A	8	8	11	11	11	11	11	11	11	11	16
Electric power supply		V _{ph} /Hz	4003-50±5%	4003-50±5%	4003-50±5%	4003-50±5%	4003-50±5%	4003-50±5%	4003-50±5%	4003-50±5%	4003-50±5%	4003-50±5%	4003-50±5%
Auxiliary power supply		V _{ph} /Hz	2301-50±5%	2301-50±5%	2301-50±5%	2301-50±5%	2301-50±5%	2301-50±5%	2301-50±5%	2301-50±5%	2301-50±5%	2301-50±5%	2301-50±5%

UNIT SIZE			40.2	43.2	47.2	51.2	54.2	61.2	70.2	73.2	80.2	85.2	90.2
Maximum absorbed power	(1),(3)	kW	194 (201)	205 (212)	232 (241)	244 (253)	266 (275)	255 (264)	289 (300)	296 (307)	315 (330)	343 (358)	367 (382)
Maximum absorbed current	(2),(3)	A	326 (342)	344 (360)	390 (409)	410 (429)	446 (465)	428 (447)	487 (510)	498 (521)	529 (559)	577 (607)	617 (647)
Maximum current at peak	(4)	A	420 (428)	420 (428)	489 (498)	508 (518)	527 (536)	508 (518)	574 (585)	574 (585)	757 (772)	766 (781)	806 (821)
Fan nominal power		rfxkW	8 x 2,0	8 x 2,0	10 x 2,0	10 x 2,0	10 x 2,0	10 x 2,0	12 x 2,0	12 x 2,0	12 x 2,0	14 x 2,0	14 x 2,0
Fan nominal current		rfxA	8 x 4,3	8 x 4,3	10 x 4,3	10 x 4,3	10 x 4,3	10 x 4,3	12 x 4,3	12 x 4,3	12 x 4,3	14 x 4,3	14 x 4,3
Pump motor nominal power		kW	8	8	9	9	9	9	11	11	15	15	15
Pump motor nominal current		A	16	16	19	19	19	19	23	23	30	30	30
Electric power supply		V _{ph} /Hz	4003-50±5%	4003-50±5%	4003-50±5%	4003-50±5%	4003-50±5%	4003-50±5%	4003-50±5%	4003-50±5%	4003-50±5%	4003-50±5%	4003-50±5%
Auxiliary power supply		V _{ph} /Hz	2301-50±5%	2301-50±5%	2301-50±5%	2301-50±5%	2301-50±5%	2301-50±5%	2301-50±5%	2301-50±5%	2301-50±5%	2301-50±5%	2301-50±5%

UNIT SIZE			95.2	100.2	105.2	115.2	120.2	130.2	140.2
Maximum absorbed power	(1),(3)	kW	386 (401)	408 (423)	425 (443)	469 (488)	506 (528)	524 (546)	542 (564)
Maximum absorbed current	(2),(3)	A	647 (678)	686 (716)	713 (750)	786 (823)	840 (882)	872 (914)	904 (946)
Maximum current at peak	(4)	A	837 (852)	875 (890)	936 (954)	1121 (1139)	1268 (1290)	1380 (1402)	1412 (1434)
Fan nominal power		rfxkW	14 x 2,0	16 x 2,0	16 x 2,0	16 x 2,0	20 x 2,0	20 x 2,0	20 x 2,0
Fan nominal current		rfxA	14 x 4,3	16 x 4,3	16 x 4,3	16 x 4,3	20 x 4,3	20 x 4,3	20 x 4,3
Pump motor nominal power		kW	15	15	19	19	22	22	22
Pump motor nominal current		A	30	30	37	37	42	42	42
Electric power supply		V _{ph} /Hz	4003-50±5%	4003-50±5%	4003-50±5%	4003-50±5%	4003-50±5%	4003-50±5%	4003-50±5%
Auxiliary power supply		V _{ph} /Hz	2301-50±5%	2301-50±5%	2301-50±5%	2301-50±5%	2301-50±5%	2301-50±5%	2301-50±5%

(1) Electric power which must be available from the electric network for the unit to function
 (2) It is the maximum current absorbed by the unit. This value is never exceeded and must be used for dimensioning the line and the relative protections (refer to the wiring diagram supplied with the units).
 (3) The values between brackets refer to the ST version units (unit with storage tank and pumps

or to units with pumps only).
 (4) Maximum peak current calculated considering the compressor start-up with higher power and maximum current absorbed by all other devices.
 This board reports the feature data of the base and standard versions; for details, refer to the specific documentation.

OPERATING LIMITS - COOLING - KAPPA V EVO

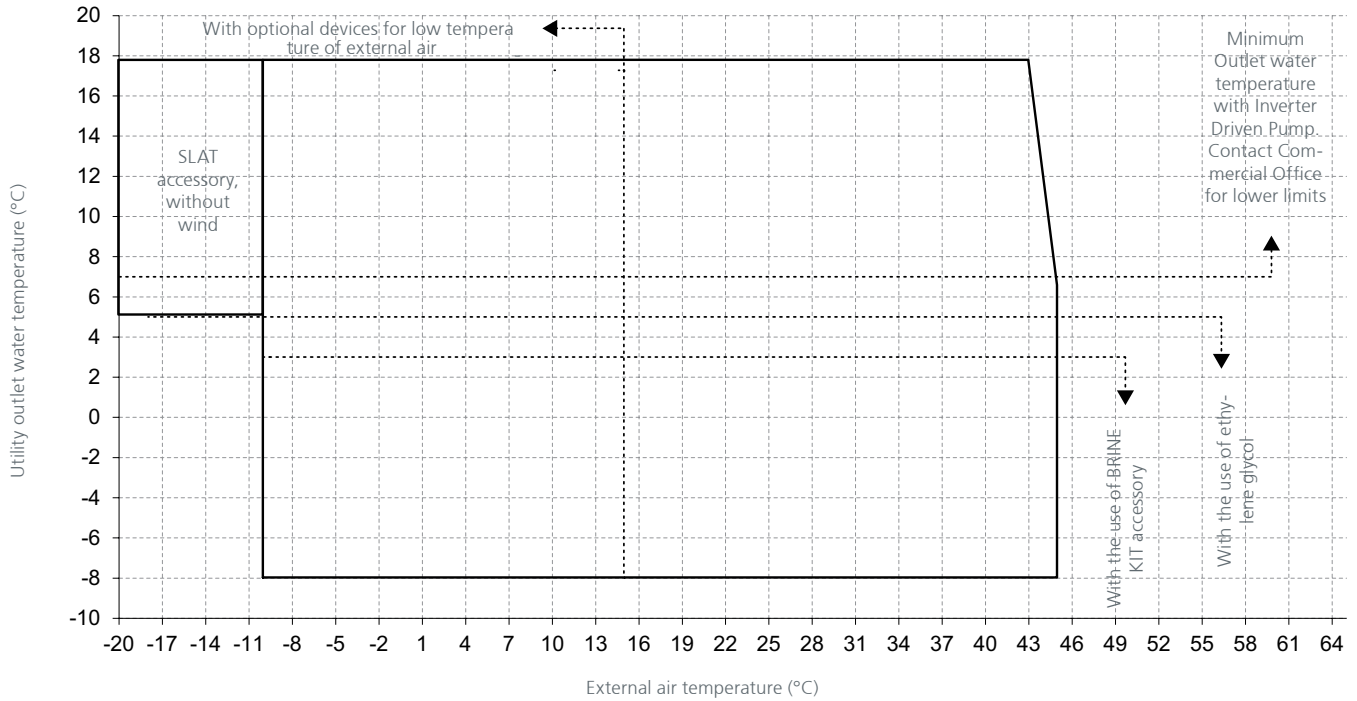

OPERATING LIMITS - HEATING - KAPPA V EVO

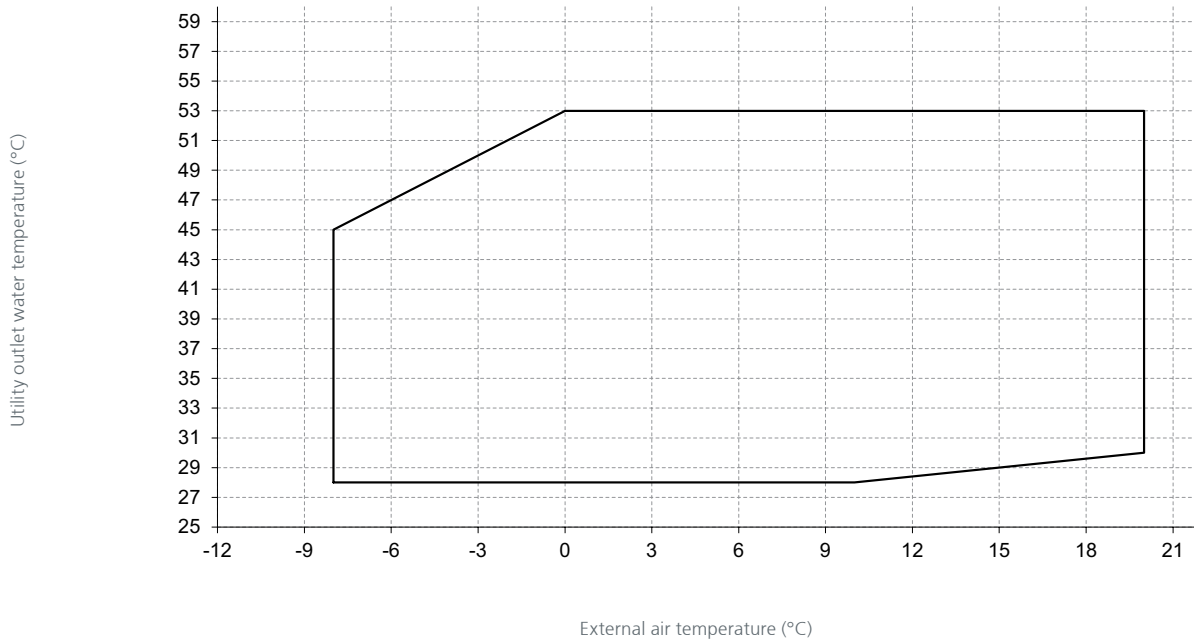

The heat drop of the water for all versions must be between 4°C e 7°C; 5°C with Inverter Driven Pump

OPERATING LIMITS - RECOVERY - KAPPA V EVO

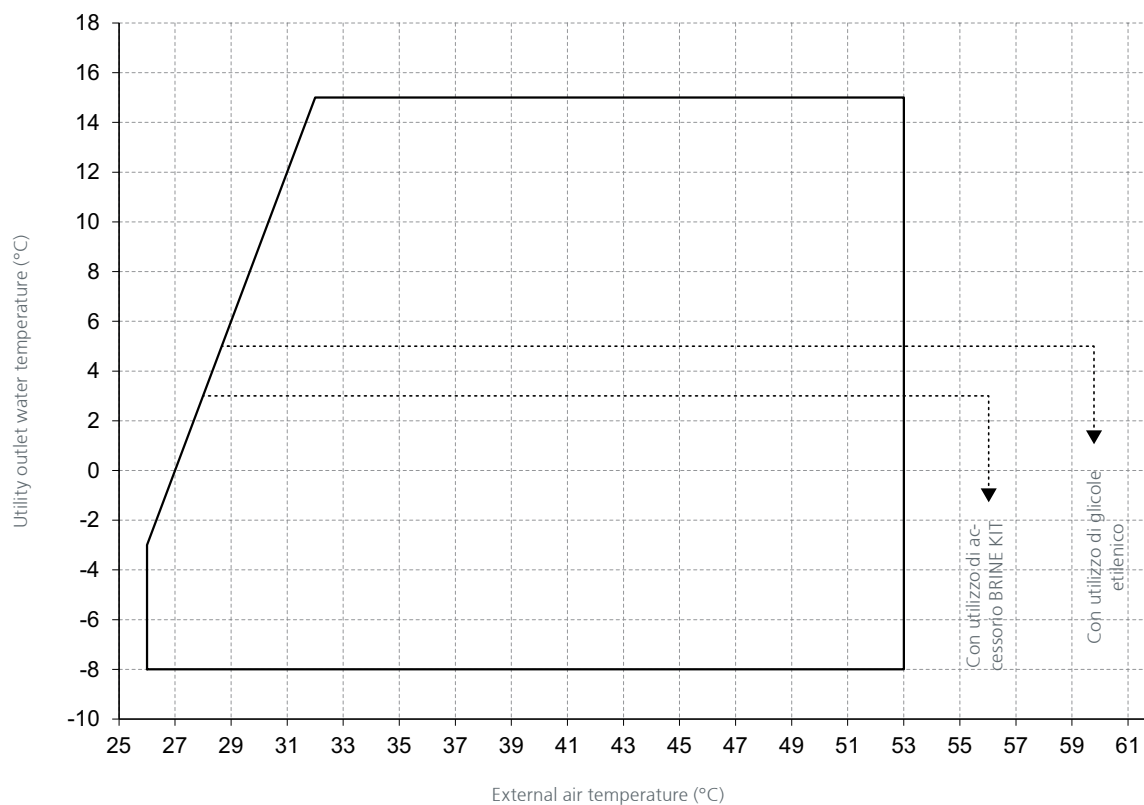

The heat drop of the water for all versions must be between 4°C e 7°C; 5°C with Inverter Driven Pump

OPERATING LIMITS - COOLING - KAPPA V EVO /A

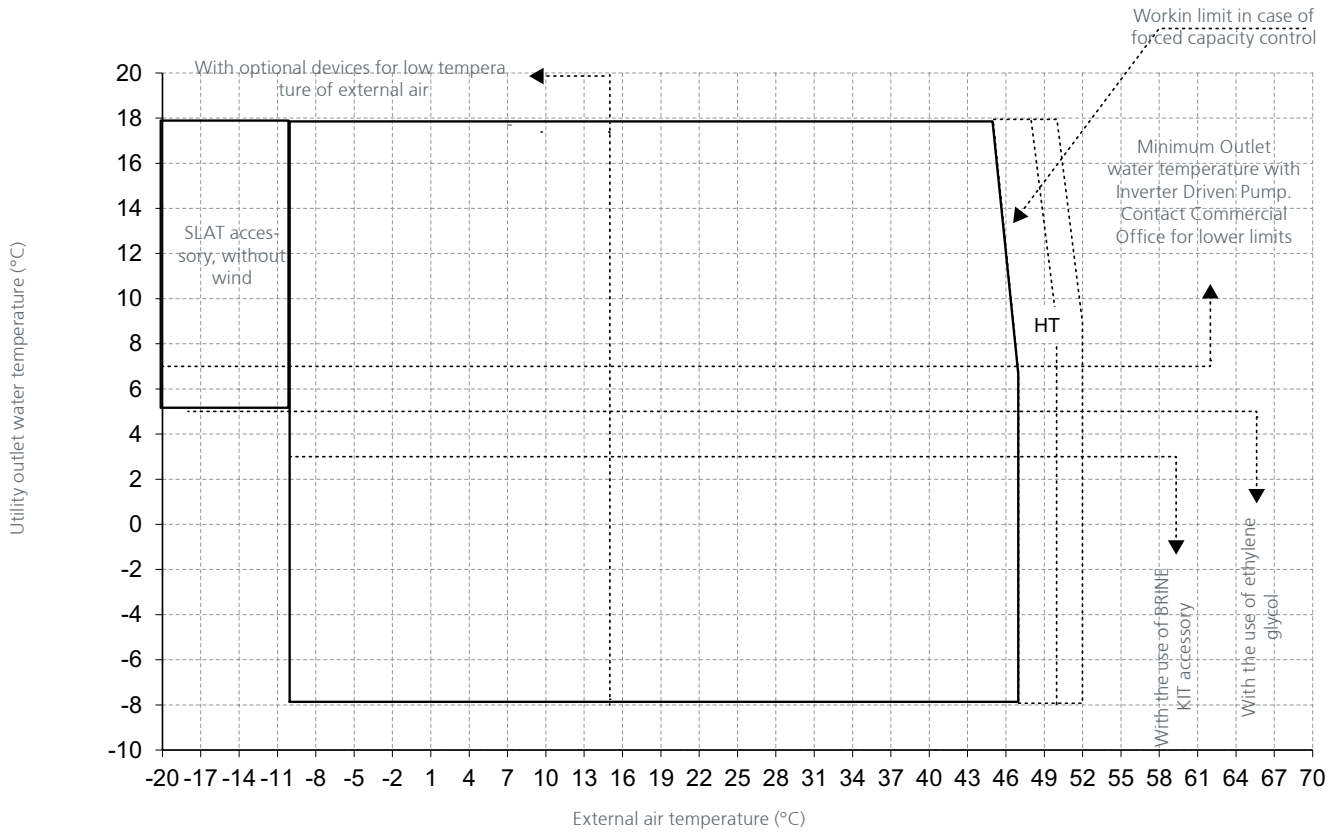

OPERATING LIMITS - HEATING - KAPPA V EVO /A

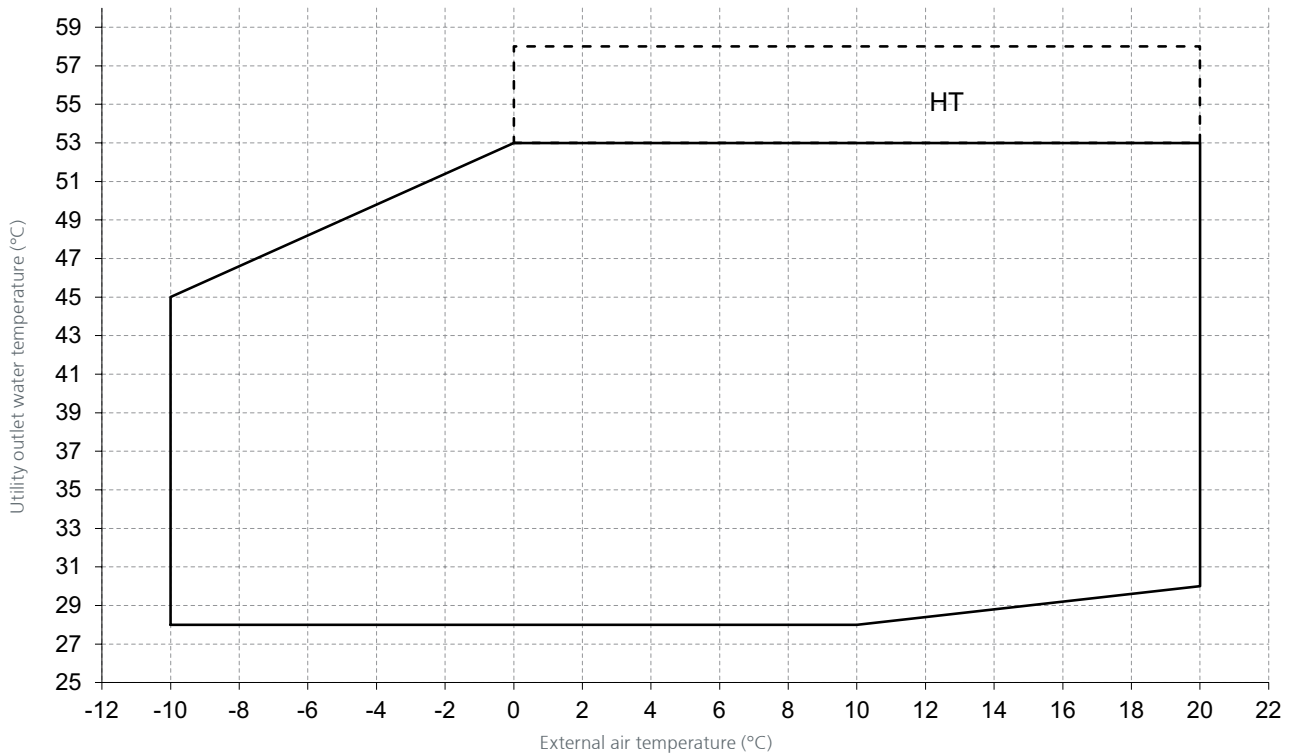

The heat drop of the water for all versions must be between 4°C e 7°C; 5°C with Inverter Driven Pump

OPERATING LIMITS - RECOVERY - KAPPA V EVO /A

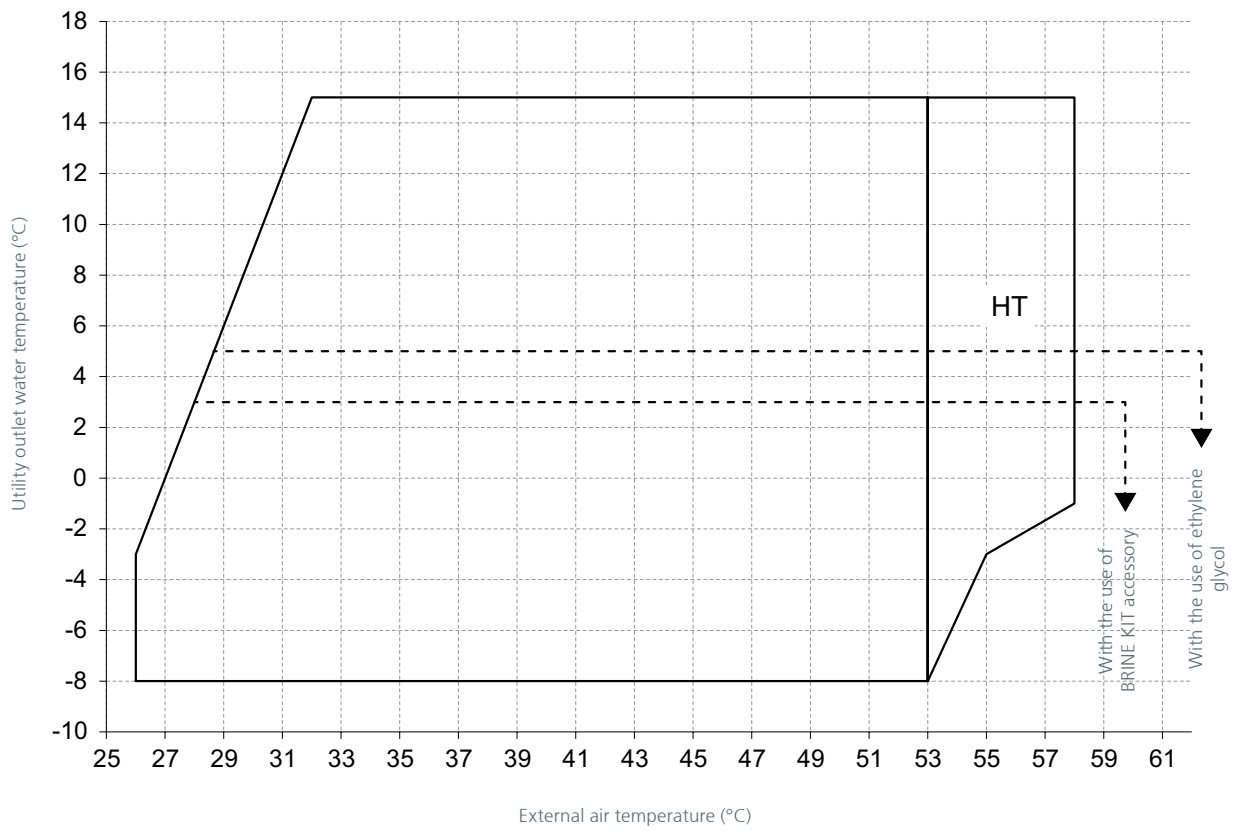

The heat drop of the water for all versions must be between 4°C e 7°C; 5°C with Inverter Driven Pump

COOLING CAPACITY - KAPPA V EVO

Model	To	EXTERNAL AIR TEMPERATURE [°C]									
	[°C]	25		30		35		40		43	
		Pf	Pe	Pf	Pe	Pf	Pe	Pf	Pe	Pf	Pe
23,1	5	250	59	235	64	219	71	202	78	191	83
	6	258	60	242	65	226	72	209	80	198	85
	7	266	61	250	66	233	73	215	81	204	86
	8	274	62	258	68	240	74	222	82	210	88
	9	282	63	265	69	248	76	229	84	217	89
25,1	10	291	64	273	70	255	77	236	85	224	91
	5	275	68	258	74	239	82	220	92	207	98
	6	283	69	265	75	247	83	227	93	214	100
	7	292	70	273	77	254	85	233	95	221	102
	8	300	71	281	78	262	87	241	97	227	104
28,1	9	309	73	290	80	269	88	248	99	234	106
	10	318	74	298	81	277	90	255	100	241	108
	5	304	73	285	79	265	88	244	98	231	105
	6	313	74	294	81	274	89	252	100	238	107
	7	323	75	303	82	282	91	260	102	246	109
31,1	8	332	77	312	84	290	93	268	103	253	111
	9	342	78	321	85	299	94	276	105	261	113
	10	352	79	331	87	308	96	284	107	269	115
	5	327	80	306	87	285	96	261	108	247	116
	6	337	81	316	89	293	98	269	110	254	118
33,2	7	347	82	325	90	302	100	278	112	262	120
	8	357	84	335	92	311	102	286	114	270	122
	9	367	86	344	94	320	104	294	116	278	125
	10	377	87	354	96	329	106	303	118	286	127
	5	350	85	330	92	307	101	284	112	269	120
35,2	6	360	86	338	93	316	102	292	114	276	122
	7	371	87	349	95	326	104	301	116	286	124
	8	382	88	360	96	336	106	311	118	295	126
	9	394	90	371	98	347	108	321	120	304	128
	10	406	91	383	100	358	110	331	122	314	131
37,2	5	379	93	357	102	332	112	306	124	290	133
	6	389	95	366	103	340	113	314	126	297	135
	7	401	96	377	105	351	116	324	129	307	138
	8	414	98	389	107	363	118	334	131	316	140
	9	427	100	401	109	374	120	345	134	327	143
40,2	10	440	102	414	111	385	123	356	136	337	146
	5	400	100	376	108	350	119	322	133	304	143
	6	413	101	387	110	360	122	331	135	313	145
	7	426	103	400	112	372	124	342	138	324	148
	8	439	105	412	115	384	126	353	141	334	151
43,2	9	452	107	425	117	396	129	365	144	345	154
	10	466	109	438	119	408	132	376	146	356	157
	5	435	108	408	118	380	130	349	145	329	156
	6	447	110	419	120	389	132	357	148	337	158
	7	460	112	432	122	401	135	369	151	348	161
47,2	8	475	114	445	125	413	138	380	154	359	165
	9	489	116	458	127	426	141	392	157	370	168
	10	503	119	472	130	439	144	403	160	381	171
	5	471	111	443	120	413	132	381	147	361	157
	6	484	112	455	122	424	134	391	149	371	159
51,2	7	500	114	470	124	438	137	404	152	383	162
	8	516	116	485	127	452	139	418	155	396	165
	9	532	118	500	129	467	142	431	157	409	168
	10	549	120	516	131	481	145	445	160	422	171
	5	506	127	474	139	440	153	404	171	381	183
55,2	6	520	129	487	141	452	156	415	174	392	186
	7	537	132	503	144	467	159	429	177	405	189
	8	554	134	519	147	482	162	443	181	418	193
	9	571	137	535	150	497	166	457	184	431	197
	10	588	139	551	153	512	169	471	188	445	201
63,2	5	537	128	502	141	465	156	426	174	401	187
	6	552	131	516	143	478	158	438	177	413	190
	7	569	133	533	146	494	161	452	180	426	194
	8	587	136	549	149	509	165	467	184	440	197
	9	605	138	566	152	525	168	481	188	454	201
10	623	141	583	155	541	172	496	192	468	206	

Pf: cooling power [kW]

Pe: electric power absorbed by compressors [kW]

Pr: recovery condenser heat power [kW]

T0: evaporator outlet water temperature [°C] Evaporator thermal gap = 5°C

COOLING CAPACITY - KAPPA V EVO

Model	To	EXTERNAL AIR TEMPERATURE [°C]									
	[°C]	25		30		35		40		43	
		Pf	Pe	Pf	Pe	Pf	Pe	Pf	Pe	Pf	Pe
54,2	5	576	141	540	154	501	171	459	191	433	205
	6	590	143	553	157	513	173	471	194	444	208
	7	609	146	570	160	530	177	486	198	459	212
	8	628	148	589	163	546	180	502	201	474	216
	9	648	151	607	166	564	184	518	205	489	220
58,2	5	668	154	626	169	581	188	534	210	504	225
	6	639	161	597	177	552	197	505	220	475	237
	6	657	164	614	180	569	200	520	225	489	241
	7	674	167	630	184	584	204	535	229	504	246
	8	693	170	648	187	600	208	550	233	518	250
61,2	9	711	173	666	191	617	212	565	237	533	255
	10	731	176	683	194	633	216	581	242	547	260
	5	685	150	643	163	598	180	550	200	520	214
	6	708	153	664	166	618	183	568	204	537	218
	7	730	156	685	169	637	187	587	208	555	222
67,2	8	752	158	706	172	657	190	605	211	572	226
	9	775	161	727	176	677	194	623	215	590	230
	10	798	164	749	179	697	197	642	219	608	235
	5	721	158	675	172	627	190	576	212	543	227
	6	744	161	697	176	647	194	594	216	561	231
70,2	7	767	164	718	179	667	197	613	220	579	235
	8	790	167	740	182	687	201	632	224	597	240
	9	813	170	762	186	708	205	651	228	615	244
	10	836	173	784	189	728	209	670	232	633	249
	5	757	181	709	197	658	218	604	242	570	260
73,2	6	780	184	731	201	678	222	623	247	588	264
	7	804	188	753	205	699	226	642	252	606	269
	8	827	191	775	209	720	230	661	256	625	274
	9	851	195	798	213	741	235	681	261	643	279
	10	876	198	821	217	762	239	701	266	662	285
80,2	5	792	184	741	200	687	221	630	246	594	264
	6	816	187	764	204	708	225	650	251	613	269
	7	840	190	786	208	729	230	669	256	631	274
	8	865	194	809	212	751	234	689	261	651	279
	9	889	198	833	216	773	239	710	266	670	284
82,2	10	915	201	856	220	795	243	730	271	689	290
	5	842	206	788	224	730	248	669	276	630	296
	6	868	209	812	229	752	253	689	282	650	302
	7	893	213	836	233	775	257	710	287	670	307
	8	920	217	860	237	798	262	731	292	690	313
85,2	9	946	221	885	242	821	267	753	298	710	319
	10	973	225	911	247	844	273	775	304	731	325
	5	877	199	822	217	763	239	701	266	662	285
	6	905	203	848	221	788	244	724	271	684	290
	7	934	206	875	225	812	248	746	276	705	295
90,2	8	961	210	900	229	836	252	768	281	726	300
	9	989	213	926	233	860	257	790	286	747	306
	10	1016	217	952	237	884	262	812	291	768	311
	5	931	211	871	230	806	254	739	283	696	303
	6	960	214	897	234	831	259	761	288	718	308
95,2	7	988	218	924	238	856	263	784	293	739	314
	8	1016	222	950	243	880	268	806	299	761	320
	9	1044	226	976	247	904	273	829	304	782	325
	10	1073	230	1003	252	929	278	852	310	804	331
	5	980	234	915	256	845	283	772	316	727	338
95,2	6	1008	238	941	261	870	288	795	322	748	344
	7	1037	243	967	266	894	294	817	327	769	351
	8	1065	247	993	271	918	299	839	333	790	357
	9	1093	252	1020	276	943	305	863	340	812	364
	10	1123	256	1047	281	968	311	885	346	834	370
95,2	5	1024	248	957	272	886	302	810	337	762	362
	6	1053	253	984	277	911	308	834	344	785	369
	7	1086	258	1015	283	940	314	860	351	810	376
	8	1119	263	1046	289	969	321	887	359	835	384
	9	1152	269	1077	296	998	328	914	366	861	393
10	1186	275	1109	302	1027	335	941	374	887	401	

Pf: cooling power [kW]

Pe: electric power absorbed by compressors [kW]

Pr: recovery condenser heat power [kW]

T0: evaporator outlet water temperature [°C] Evaporator thermal gap = 5°C

COOLING CAPACITY - KAPPA V EVO

Model	To	EXTERNAL AIR TEMPERATURE [°C]									
	[°C]	25		30		35		40		43	
		Pf	Pe	Pf	Pe	Pf	Pe	Pf	Pe	Pf	Pe
100,2	5	1068	263	998	288	922	320	842	358	792	384
	6	1099	268	1026	294	949	326	867	365	815	391
	7	1132	273	1058	300	978	333	894	373	841	400
	8	1167	279	1090	307	1008	340	922	381	867	408
	9	1202	285	1122	313	1039	348	950	389	894	417
105,2	5	1121	280	1048	306	970	338	887	376	835	402
	6	1155	285	1079	312	999	344	913	383	860	410
	7	1188	291	1110	318	1027	351	939	391	885	418
	8	1221	296	1141	324	1056	358	966	398	910	426
	9	1254	302	1171	331	1084	365	992	406	935	434
110,2	5	1180	291	1102	319	1019	353	930	394	873	423
	6	1212	296	1132	325	1046	360	955	402	897	431
	7	1248	303	1166	332	1078	368	984	411	925	440
	8	1285	309	1200	340	1110	376	1014	420	954	450
	9	1322	316	1235	348	1143	385	1044	429	982	460
115,2	5	1278	304	1195	332	1108	368	1014	411	956	441
	6	1313	309	1229	338	1139	374	1043	418	983	448
	7	1355	315	1268	345	1175	382	1077	427	1015	457
	8	1397	321	1307	352	1212	390	1111	435	1048	466
	9	1439	327	1347	359	1249	398	1146	444	1081	476
120,2	5	1482	334	1387	367	1287	406	1181	454	1115	486
	6	1521	341	1432	375	1328	414	1220	463	1154	495
	7	1564	348	1481	384	1372	422	1262	472	1197	504
	8	1607	355	1533	393	1418	431	1307	481	1244	513
	9	1652	362	1588	402	1468	440	1356	490	1294	522
130,2	5	1700	369	1644	411	1519	449	1408	499	1346	531
	6	1745	376	1703	420	1572	458	1464	508	1402	540
	7	1793	384	1765	429	1628	467	1523	517	1460	549
	8	1843	392	1831	438	1687	476	1586	526	1522	558
	9	1895	400	1901	447	1750	485	1653	535	1588	567
140,2	5	1950	408	1975	456	1818	494	1724	544	1659	576
	6	2007	416	2054	465	1890	503	1799	553	1734	585
	7	2067	424	2143	474	1967	512	1878	562	1813	594
	8	2129	432	2241	483	2050	521	1961	571	1900	603
	9	2193	440	2349	492	2138	530	2049	580	1992	612
150,4	5	2260	448	2467	501	2230	539	2142	589	2090	621
	6	2327	456	2595	510	2327	548	2240	598	2194	630
	7	2397	464	2733	519	2428	557	2343	607	2303	639
	8	2470	472	2881	528	2534	566	2451	616	2418	648
	9	2545	480	3041	537	2646	575	2564	625	2539	657
160,4	5	2624	488	3213	546	2764	584	2682	634	2664	666
	6	2707	496	3400	555	2888	593	2815	643	2794	675
	7	2793	504	3603	564	3018	602	2954	652	2930	684
	8	2883	512	3823	573	3154	611	3100	661	3072	693
	9	2975	520	4061	582	3306	620	3253	670	3221	702
180,4	5	3070	528	4317	591	3474	629	3424	679	3378	711
	6	3169	536	4593	600	3658	638	3609	688	3534	720
	7	3271	544	4887	609	3858	647	3808	697	3700	729
	8	3385	552	5201	618	4074	656	4021	706	3876	738
	9	3501	560	5537	627	4308	665	4250	715	4062	747

Pf: cooling power [kW]

Pe: electric power absorbed by compressors [kW]

Pr: recovery condenser heat power [kW]

T0: evaporator outlet water temperature [°C] Evaporator thermal gap = 5°C

HEATING CAPACITY - KAPPA V EVO

Model	INPUT WATER TEMPERATURE TO CONDENSER [°C]									
	Ta [°C]	RH %	30/35		35/40		40/45		45/50	
			Pt	Pe	Pt	Pe	Pt	Pe	Pt	Pe
23,1	-8	95	153	46	150	49	149	55	148	61
	-5	90	168	47	165	51	163	56	162	63
	0	80	193	50	190	54	188	59	186	67
	5	80	220	52	216	56	214	62	212	70
	7	70	229	53	226	57	223	63	221	71
10	70	248	54	244	59	240	65	237	73	
25,1	-8	95	174	52	173	56	172	63	172	71
	-5	90	190	53	188	58	187	65	185	73
	0	80	222	56	219	61	217	68	215	76
	5	80	249	58	245	63	242	70	241	79
	7	70	260	59	256	64	253	71	251	80
10	70	282	61	277	66	272	73	270	82	
28,1	-8	95	190	57	188	62	186	69	185	78
	-5	90	207	59	205	64	204	71	202	80
	0	80	236	61	234	66	232	74	230	83
	5	80	267	64	264	69	262	77	261	87
	7	70	271	64	270	70	269	78	269	88
10	70	289	65	287	71	284	79	283	89	
31,1	-8	95	209	62	202	67	200	74	203	85
	-5	90	225	64	222	69	222	77	221	87
	0	80	258	67	256	73	253	80	251	91
	5	80	295	70	291	76	288	84	286	95
	7	70	305	70	301	77	299	85	297	96
10	70	327	72	323	78	321	87	316	98	
33,2	-8	95	221	66	218	71	216	79	216	89
	-5	90	243	68	244	74	237	81	237	92
	0	80	279	72	275	77	273	86	272	97
	5	80	317	75	314	81	311	90	310	102
	7	70	330	76	327	83	324	92	324	104
10	70	356	78	349	85	346	95	344	107	
35,2	-8	95	230	76	226	82	223	91	222	102
	-5	90	255	79	250	85	247	94	245	106
	0	80	294	83	289	90	286	99	284	112
	5	80	337	87	332	94	328	105	325	118
	7	70	351	88	346	96	342	107	339	120
10	70	380	91	372	99	367	110	364	124	
37,2	-8	95	247	78	241	84	235	92	212	101
	-5	90	276	81	270	87	265	96	262	108
	0	80	322	85	316	92	312	102	309	115
	5	80	370	90	364	97	359	108	356	121
	7	70	387	91	381	99	376	110	372	124
10	70	418	94	407	102	402	113	398	127	
40,2	-8	95	232	78	239	86	226	94	264	111
	-5	90	279	83	241	86	244	96	245	109
	0	80	340	88	332	96	326	106	270	112
	5	80	392	93	384	101	377	111	371	125
	7	70	413	94	406	103	399	114	393	128
10	70	447	97	437	105	431	117	425	132	
43,2	-8	95	302	101	299	110	296	121	295	137
	-5	90	333	105	326	113	322	125	319	141
	0	80	378	110	373	119	370	132	367	148
	5	80	417	114	413	124	410	137	409	155
	7	70	433	115	427	125	423	139	420	156
10	70	469	118	461	129	455	143	449	160	
47,2	-8	95	323	102	320	110	316	122	315	137
	-5	90	356	105	350	114	345	126	343	142
	0	80	403	110	398	119	395	132	392	149
	5	80	450	114	447	125	444	138	442	156
	7	70	459	115	455	125	453	139	452	157
10	70	492	118	489	129	486	143	477	160	
51,2	-8	95	332	104	328	113	326	125	324	141
	-5	90	365	108	360	117	356	129	359	146
	0	80	414	112	409	122	405	135	404	152
	5	80	468	117	463	127	459	141	457	159
	7	70	474	117	471	128	469	142	469	161
10	70	504	120	506	131	503	146	493	164	

Pt: heat power [kW]

Pe: power absorbed by compressors [kW]

Ta: Dry bulb temperature of the evaporator inlet air [°C]

RH: relative humidity of the input air at the evaporator [%]

HEATING CAPACITY - KAPPA V EVO

Model	INPUT WATER TEMPERATURE TO CONDENSER [°C]									
	Ta [°C]	RH %	30/35		35/40		40/45		45/50	
			Pt	Pe	Pt	Pe	Pt	Pe	Pt	Pe
54,2	-8	95	374	124	371	135	366	150	365	169
	-5	90	409	128	403	139	399	154	396	173
	0	80	466	134	461	145	457	161	454	182
	5	80	513	138	507	150	504	167	504	188
	7	70	536	140	528	152	522	169	519	190
58,2	-8	95	417	125	413	135	411	150	410	169
	-5	90	458	129	453	140	449	155	446	174
	0	80	518	135	513	146	509	162	506	183
	5	80	576	139	571	152	570	169	570	191
	7	70	586	140	581	153	579	170	578	191
61,2	-8	95	424	122	418	132	413	147	413	166
	-5	90	462	126	456	136	451	151	447	171
	0	80	527	131	521	143	517	158	514	179
	5	80	596	137	589	149	585	166	582	187
	7	70	604	137	601	150	599	167	598	189
67,2	-8	95	439	128	434	138	431	154	430	174
	-5	90	482	132	474	143	470	158	465	178
	0	80	550	138	543	149	539	166	536	187
	5	80	621	143	615	156	610	173	608	196
	7	70	637	144	634	158	631	175	628	198
70,2	-8	95	472	137	464	149	458	165	455	186
	-5	90	520	142	511	153	507	170	503	192
	0	80	600	148	590	161	583	179	578	202
	5	80	686	155	675	169	667	187	661	211
	7	70	714	157	706	171	699	190	693	215
73,2	-8	95	479	141	469	152	463	169	460	191
	-5	90	527	145	519	157	512	174	507	197
	0	80	608	152	598	165	590	183	585	207
	5	80	696	159	684	173	676	192	669	217
	7	70	726	161	716	176	708	195	701	220
80,2	-8	95	523	151	516	164	510	181	506	205
	-5	90	572	155	565	169	555	187	550	211
	0	80	651	162	643	176	635	195	630	221
	5	80	739	169	730	184	723	204	717	231
	7	70	763	171	754	186	747	207	742	234
	10	70	815	174	808	190	796	212	787	239

Pt: heat power [kW]

Pe: power absorbed by compressors [kW]

Ta: Dry bulb temperature of the evaporator inlet air [°C]

RH: relative humidity of the input air at the evaporator [%]

COOLING CAPACITY - KAPPA V EVO /SLN

Model	To	EXTERNAL AIR TEMPERATURE [°C]									
	[°C]	25		30		35		40		43	
		Pf	Pe	Pf	Pe	Pf	Pe	Pf	Pe	Pf	Pe
23,1	5	249	59	234	65	218	71	201	79	190	84
	6	257	60	241	66	225	72	207	80	197	86
	7	264	61	249	67	232	74	214	82	203	87
	8	272	62	256	68	239	75	221	83	209	89
	9	281	64	264	69	246	76	227	85	216	90
25,1	5	274	68	257	75	238	83	219	92	206	99
	6	282	69	264	76	245	84	225	94	213	101
	7	290	71	272	77	253	86	232	96	219	103
	8	299	72	280	79	260	87	239	98	226	105
	9	307	73	288	80	268	89	246	99	233	107
28,1	5	316	74	296	82	275	91	253	101	239	109
	6	308	76	288	83	267	92	244	104	230	111
	7	318	77	297	85	275	94	252	106	237	114
	8	327	78	306	86	283	96	259	108	244	116
	9	337	80	315	88	292	98	267	110	252	118
31,1	5	347	81	324	89	300	100	275	112	259	120
	6	322	81	301	89	278	100	253	112	238	120
	7	332	83	310	91	286	101	261	114	245	123
	7	342	84	319	93	294	103	269	116	252	125
	8	352	86	328	95	303	105	277	118	260	127
33,2	5	362	87	338	96	312	108	285	121	268	130
	6	372	89	347	98	321	110	293	123	275	132
	7	349	85	328	92	306	101	282	113	267	121
	7	359	86	337	93	314	103	290	115	274	123
	8	370	87	348	95	324	105	299	117	283	125
35,2	5	382	89	359	97	335	107	309	119	292	127
	6	394	90	370	98	345	109	319	121	302	130
	7	406	92	381	100	356	110	328	123	311	132
	8	378	93	355	102	330	112	304	125	287	134
	9	388	94	364	103	338	114	311	127	294	136
37,2	5	400	96	376	105	349	116	321	129	304	138
	6	413	98	387	107	360	118	332	132	314	141
	7	426	100	400	109	372	120	342	134	324	144
	8	439	101	412	111	383	123	353	137	334	147
	9	452	103	424	113	394	125	364	139	344	149
40,2	5	435	100	407	109	378	120	346	134	302	144
	6	412	102	386	111	359	122	329	137	311	147
	7	425	103	398	113	370	125	340	139	321	149
	8	438	105	411	115	382	127	351	142	331	152
	9	452	107	424	117	394	130	362	145	342	155
43,2	5	466	109	437	120	406	132	373	148	353	158
	6	435	110	407	120	378	133	346	149	326	160
	7	446	111	417	122	387	135	355	151	334	162
	7	460	114	431	125	399	138	366	154	345	166
	8	474	116	444	127	411	141	377	157	356	169
47,2	5	489	118	457	130	424	144	389	161	367	172
	6	503	121	471	132	437	147	400	164	378	176
	7	472	114	443	124	413	136	380	152	360	162
	7	485	115	455	126	424	138	391	154	370	165
	8	501	117	470	128	438	141	404	157	382	168
51,2	5	517	119	485	130	452	144	417	160	395	171
	6	533	122	501	133	466	146	430	163	407	174
	7	550	124	516	135	481	149	444	166	420	177
	8	505	130	472	142	438	157	401	175	378	188
	7	519	132	486	145	450	160	412	178	389	191
51,2	5	536	135	501	147	465	163	426	182	402	195
	6	552	137	517	150	479	166	440	186	415	199
	7	570	140	533	153	494	170	453	189	428	203
	8	587	143	549	157	510	173	468	193	441	207
	7	536	139	501	152	463	169	424	189	398	203
6	551	141	515	155	476	172	435	192	410	206	
7	568	144	531	158	492	175	450	196	423	211	
8	586	147	548	161	507	179	464	200	437	215	
9	604	149	564	164	523	183	478	204	450	219	
10	622	152	582	168	539	186	493	209	464	224	

Pf: cooling power [kW]

Pe: electric power absorbed by compressors [kW]

Pr: recovery condenser heat power [kW]

T0: evaporator outlet water temperature [°C] Evaporator thermal gap = 5°C

COOLING CAPACITY - KAPPA V EVO /SLN

Model	To	EXTERNAL AIR TEMPERATURE [°C]									
	[°C]	25		30		35		40		43	
		Pf	Pe	Pf	Pe	Pf	Pe	Pf	Pe	Pf	Pe
54,2	5	566	149	529	163	489	182	447	204	420	219
	6	580	151	542	166	501	184	458	207	430	222
	7	598	154	559	169	517	188	472	211	444	227
	8	617	157	576	173	533	192	487	215	458	232
	9	636	160	594	176	549	196	502	220	473	236
58,2	10	655	163	612	180	566	200	518	225	487	241
	5	628	164	585	180	539	201	490	226	460	243
	6	646	167	602	184	555	205	505	230	473	248
	7	662	170	617	187	569	209	519	235	487	253
	8	680	173	634	191	585	213	533	240	501	258
61,2	9	698	176	651	195	601	218	548	244	514	263
	10	717	180	668	199	616	222	562	249	528	268
	5	672	158	629	173	583	191	535	213	504	228
	6	694	161	649	176	602	194	552	217	521	232
	7	715	164	670	179	621	198	570	221	538	237
67,2	8	737	167	690	182	640	202	587	225	554	241
	9	759	170	710	186	659	206	605	229	571	246
	10	781	173	731	189	678	210	623	234	588	250
	5	707	169	661	184	612	204	560	228	527	244
	6	729	172	682	188	631	208	578	232	544	249
70,2	7	751	175	702	191	650	212	595	237	561	254
	8	774	178	723	195	670	216	613	241	578	259
	9	796	181	744	199	689	220	631	246	595	264
	10	819	185	765	203	709	225	650	251	612	269
	5	744	186	695	203	642	225	587	251	552	269
73,2	6	766	189	716	207	662	229	605	256	569	274
	7	789	193	737	211	682	234	623	261	587	280
	8	812	196	758	215	701	238	642	266	604	285
	9	835	200	780	219	722	243	660	271	622	291
	10	858	204	802	224	742	248	679	277	639	297
80,2	5	780	193	728	211	672	234	613	261	577	280
	6	803	196	750	215	692	238	632	266	594	285
	7	827	200	771	219	713	243	651	271	612	291
	8	851	204	794	224	733	248	670	277	630	297
	9	875	208	816	228	754	253	689	283	648	303
82,2	10	899	212	839	233	775	258	708	288	667	309
	5	812	210	755	230	696	255	632	286	593	307
	6	835	214	777	235	716	261	651	292	610	313
	7	859	218	799	240	736	266	670	298	628	319
	8	883	223	822	245	757	272	689	304	646	326
85,2	9	907	227	844	250	778	278	708	310	664	333
	10	932	232	867	256	799	284	728	317	683	340
	5	861	204	805	223	745	247	682	275	642	295
	6	889	208	830	227	769	252	703	281	663	301
	7	916	212	855	232	792	256	725	286	683	307
90,2	8	942	216	880	236	814	261	746	291	703	312
	9	969	219	904	241	837	266	766	297	723	318
	10	995	223	929	245	860	271	788	302	742	324
	5	906	221	844	242	779	269	711	300	668	322
	6	933	225	870	247	803	274	732	306	688	328
95,2	7	960	230	895	252	826	279	753	312	708	334
	8	987	234	919	257	849	285	774	318	728	340
	9	1013	238	944	262	872	290	796	324	748	347
	10	1041	243	969	267	895	296	817	330	768	353
	5	964	241	897	264	826	293	751	328	704	352
95,2	6	991	245	922	270	849	299	772	335	724	359
	7	1018	250	947	275	872	305	793	341	744	366
	8	1045	255	972	280	895	311	814	347	763	373
	9	1073	260	997	286	918	317	836	354	784	380
	10	1101	265	1023	292	942	324	857	361	804	387
95,2	5	1008	260	938	286	863	319	784	357	734	384
	6	1036	265	964	292	887	325	806	365	755	392
	7	1067	271	993	299	914	333	830	373	778	400
	8	1098	277	1022	306	941	341	855	382	801	409
	9	1130	283	1051	313	968	349	880	390	825	419
10	1162	290	1081	321	996	357	905	399	849	428	

Pf: cooling power [kW]

Pe: electric power absorbed by compressors [kW]

Pr: recovery condenser heat power [kW]

T0: evaporator outlet water temperature [°C] Evaporator thermal gap = 5°C

COOLING CAPACITY - KAPPA V EVO /SLN

Model	To	EXTERNAL AIR TEMPERATURE [°C]									
	[°C]	25		30		35		40		43	
		Pf	Pe	Pf	Pe	Pf	Pe	Pf	Pe	Pf	Pe
100,2	5	1055	268	980	296	899	330	814	370	760	398
	6	1084	274	1006	302	924	337	836	378	781	406
	7	1116	280	1036	310	951	345	861	387	805	416
	8	1148	287	1066	317	979	353	886	396	828	425
	9	1180	293	1096	325	1006	362	912	405	852	435
105,2	5	1103	286	1027	314	947	349	862	389	808	417
	6	1136	292	1057	321	974	356	886	397	832	426
	7	1168	298	1087	327	1001	363	911	405	855	434
	8	1200	304	1116	334	1028	370	936	413	879	443
	9	1231	310	1146	341	1056	378	961	422	902	451
110,2	5	1163	313	1082	345	995	384	902	431	844	462
	6	1194	320	1110	352	1021	392	926	439	866	471
	7	1229	327	1143	361	1051	401	954	449	893	482
	8	1264	335	1176	369	1082	411	982	460	919	493
	9	1300	342	1209	378	1112	421	1010	471	946	505
115,2	5	1257	311	1172	342	1081	380	986	425	925	457
	6	1291	316	1204	348	1111	387	1013	433	951	465
	7	1331	323	1241	355	1146	395	1045	442	981	475
	8	1371	330	1279	363	1181	404	1077	452	1012	485
	9	1412	337	1317	371	1216	413	1110	462	1043	495
120,2	5	1347	338	1261	366	1170	397	1077	433	1019	456
	6	1385	344	1296	372	1203	404	1107	440	1047	464
	7	1423	350	1332	379	1236	411	1137	447	1075	471
	8	1462	357	1368	385	1269	418	1167	455	1104	479
	9	1501	363	1404	392	1303	425	1198	462	1134	486
130,2	5	1347	338	1261	366	1170	397	1077	433	1019	456
	6	1385	344	1296	372	1203	404	1107	440	1047	464
	7	1423	350	1332	379	1236	411	1137	447	1075	471
	8	1462	357	1368	385	1269	418	1167	455	1104	479
	9	1501	363	1404	392	1303	425	1198	462	1134	486
140,2	5	1441	399	1344	432	1242	470	1137	511	1073	539
	6	1480	406	1380	440	1276	478	1168	520	1101	548
	7	1519	414	1416	448	1309	486	1198	529	1130	557
	8	1559	421	1454	456	1343	495	1229	538	1159	566
	9	1600	430	1492	465	1379	504	1262	548	1189	576
150,4	5	1556	410	1452	450	1342	500	1224	559	1150	600
	6	1601	418	1495	459	1381	510	1260	571	1184	612
	7	1650	426	1540	469	1424	521	1299	583	1221	626
	8	1700	436	1587	479	1467	533	1339	596	1259	639
	9	1750	445	1634	490	1510	545	1379	609	1297	653
160,4	5	1615	418	1506	459	1389	510	1265	571	1187	614
	6	1662	426	1550	469	1430	521	1303	583	1222	626
	7	1712	435	1597	479	1473	533	1343	596	1260	640
	8	1763	445	1644	490	1518	545	1383	610	1299	654
	9	1815	454	1692	501	1562	557	1424	623	1338	669
180,4	5	1875	504	1733	555	1583	618	1425	693	1326	744
	6	1922	514	1777	567	1623	631	1461	707	1360	759
	7	1972	525	1822	580	1665	645	1499	722	1395	775
	8	2021	537	1868	593	1707	659	1537	738	1430	791
	9	2072	549	1915	607	1750	675	1576	754	1467	809
	10	2124	562	1964	621	1794	691	1616	772	1505	827

Pf: cooling power [kW]
 Pe: electric power absorbed by compressors [kW]
 Pr: recovery condenser heat power [kW]
 T0: evaporator outlet water temperature [°C] Evaporator thermal gap = 5°C

HEATING CAPACITY - KAPPA V EVO /SLN

Model	INPUT WATER TEMPERATURE TO CONDENSER [°C]									
	Ta [°C]	RH %	30/35		35/40		40/45		45/50	
			Pt	Pe	Pt	Pe	Pt	Pe	Pt	Pe
23,1	-8	95	158	47	156	50	154	56	153	63
	-5	90	170	48	169	52	167	57	167	65
	0	80	195	50	193	54	192	60	191	68
	5	80	223	53	219	57	219	63	221	72
	7	70	233	53	229	58	226	64	224	72
25,1	10	70	253	55	249	60	244	66	242	74
	-8	95	177	53	175	57	172	63	171	71
	-5	90	194	54	191	59	188	65	187	74
	0	80	221	57	218	61	216	68	214	77
	5	80	252	59	249	64	246	71	244	80
28,1	7	70	260	59	257	65	253	72	251	81
	10	70	275	61	272	66	268	73	265	83
	-8	95	187	57	185	62	183	68	182	77
	-5	90	205	58	202	63	200	70	199	79
	0	80	235	61	232	66	229	74	227	83
31,1	5	80	268	64	264	69	261	77	259	87
	7	70	278	64	274	70	271	78	268	88
	10	70	300	66	296	72	290	80	287	90
	-8	95	204	62	201	67	199	74	199	84
	-5	90	224	64	220	69	218	77	217	87
33,2	0	80	255	66	252	72	249	80	247	90
	5	80	291	69	287	75	284	84	281	94
	7	70	303	70	298	76	295	85	291	95
	10	70	328	72	322	78	316	87	312	98
	-8	95	232	68	230	73	228	81	228	91
35,2	-5	90	249	69	248	75	247	83	248	94
	0	80	284	73	282	79	282	88	282	99
	5	80	324	76	319	83	320	92	324	105
	7	70	335	77	331	84	329	93	328	105
	10	70	364	80	359	87	355	96	353	109
37,2	-8	95	240	78	237	84	234	93	233	105
	-5	90	261	80	258	87	256	96	255	108
	0	80	298	84	295	91	292	101	289	113
	5	80	338	88	334	95	331	106	329	119
	7	70	344	88	343	96	341	107	339	121
40,2	10	70	366	90	364	99	358	109	355	123
	-8	95	259	79	254	86	256	95	253	107
	-5	90	285	82	280	89	277	98	275	110
	0	80	327	86	322	93	316	103	314	116
	5	80	372	90	367	98	363	109	359	123
43,2	7	70	385	91	380	100	375	110	371	124
	10	70	413	94	407	102	401	113	397	128
	-8	95	270	82	265	89	261	99	258	111
	-5	90	298	85	292	92	288	102	285	115
	0	80	344	89	338	97	332	107	329	120
47,2	5	80	394	93	387	102	382	113	377	127
	7	70	411	95	403	103	397	114	392	129
	10	70	440	97	433	106	427	117	422	132
	-8	95	300	102	296	110	292	122	291	137
	-5	90	330	105	324	114	320	126	318	142
51,2	0	80	379	111	373	120	368	133	365	149
	5	80	433	116	426	126	421	140	416	157
	7	70	452	118	445	128	438	142	433	159
	10	70	489	121	480	131	472	145	466	163
	-8	95	326	103	321	111	317	123	317	139
51,2	-5	90	356	106	351	115	348	127	346	143
	0	80	412	112	406	121	402	134	399	151
	5	80	468	117	461	127	455	141	452	158
	7	70	487	118	480	129	475	143	470	160
	10	70	529	122	520	132	512	147	507	165
51,2	-8	95	338	106	333	114	330	127	330	143
	-5	90	369	109	364	118	361	131	360	148
	0	80	428	114	423	124	419	138	417	155
	5	80	485	119	476	130	471	144	468	162
	7	70	503	121	496	131	491	146	488	164
10	70	546	124	538	135	531	150	526	169	

Pt: heat power [kW]

Pe: power absorbed by compressors [kW]

Ta: Dry bulb temperature of the evaporator inlet air [°C]

RH: relative humidity of the input air at the evaporator [%]

HEATING CAPACITY - KAPPA V EVO /SLN

Model	INPUT WATER TEMPERATURE TO CONDENSER [°C]									
	Ta [°C]	RH %	30/35		35/40		40/45		45/50	
			Pt	Pe	Pt	Pe	Pt	Pe	Pt	Pe
54,2	-8	95	363	123	357	133	354	148	353	167
	-5	90	396	127	391	137	387	152	385	172
	0	80	455	133	448	144	443	160	440	180
	5	80	519	139	511	151	505	167	501	188
	7	70	541	140	533	153	526	169	521	190
58,2	10	70	585	144	576	157	568	174	560	195
	-8	95	409	124	403	134	399	149	398	168
	-5	90	446	128	440	138	436	153	434	173
	0	80	511	134	504	145	499	161	497	181
	5	80	587	140	574	152	568	169	564	190
61,2	7	70	607	142	598	154	592	171	587	192
	10	70	658	145	648	158	640	175	634	197
	-8	95	420	122	415	132	411	147	412	166
	-5	90	455	125	450	136	447	151	447	171
	0	80	523	131	516	142	513	158	512	179
67,2	5	80	600	137	589	149	583	166	579	187
	7	70	622	139	613	151	607	168	604	190
	10	70	674	143	665	156	657	173	651	195
	-8	95	444	128	441	139	435	154	437	175
	-5	90	475	131	472	143	471	159	471	179
70,2	0	80	545	137	541	149	539	166	540	188
	5	80	626	144	615	156	609	173	606	196
	7	70	648	145	639	158	634	176	631	199
	10	70	702	149	693	163	686	181	682	204
	-8	95	484	138	476	150	472	166	470	188
73,2	-5	90	523	142	515	154	511	171	509	193
	0	80	595	148	590	161	585	179	583	202
	5	80	680	155	668	168	662	187	659	211
	7	70	680	155	675	169	673	188	673	213
	10	70	724	158	720	173	717	192	713	217
80,2	-8	95	484	141	476	153	472	170	470	192
	-5	90	527	145	521	158	515	175	512	198
	0	80	601	152	594	165	589	183	585	207
	5	80	687	158	673	172	667	191	663	216
	7	70	694	159	690	174	686	193	683	218
80,2	10	70	737	162	733	177	728	197	723	223
	-8	95	508	149	502	161	495	179	494	202
	-5	90	549	152	545	166	542	184	540	208
	0	80	625	159	620	173	616	192	612	217
	5	80	719	166	705	181	698	201	692	227
7	70	725	167	713	181	714	202	714	229	
10	70	760	169	758	185	759	207	758	234	

Pt: heat power [kW]

Pe: power absorbed by compressors [kW]

Ta: Dry bulb temperature of the evaporator inlet air [°C]

RH: relative humidity of the input air at the evaporator [%]

RECOVERY CAPACITY - KAPPA V EVO

Model	To	OUTPUT WATER TEMPERATURE FROM CONDENSER [°C]														
	[°C]	30			35			40			45			50		
		Pf	Pe	Pr	Pf	Pe	Pr	Pf	Pe	Pr	Pf	Pe	Pr	Pf	Pe	Pr
23,1	6	286	52	338	270	56	326	253	61	314	236	67	303	217	75	292
	7	296	53	349	280	56	336	263	61	324	245	68	312	225	75	301
	8	307	53	360	290	57	347	272	62	334	254	68	322	234	76	310
	9	318	54	371	300	57	358	282	63	345	263	69	332	243	77	320
25,1	10	329	54	383	311	58	369	292	63	355	273	70	342	252	77	329
	6	319	58	377	301	62	364	283	68	351	263	75	338	242	84	326
	7	330	59	389	312	63	375	293	69	361	273	76	348	251	85	336
	8	342	59	401	323	63	387	303	69	373	283	76	359	261	86	346
28,1	9	354	60	414	335	64	399	314	70	384	293	77	370	271	86	357
	10	366	60	426	346	64	411	326	70	396	304	78	381	281	87	367
	6	346	65	411	327	69	396	307	75	382	286	83	369	263	93	356
	7	359	65	424	339	70	409	318	76	394	296	84	380	273	94	367
31,1	8	371	66	437	351	70	422	330	77	407	307	85	392	284	95	379
	9	384	66	450	364	71	435	342	77	419	319	85	404	294	96	390
	10	398	67	464	377	71	448	354	78	432	330	86	416	305	96	402
	6	375	70	445	354	75	429	332	82	414	309	90	399	285	101	386
33,2	7	388	71	458	367	75	442	344	82	427	321	91	412	296	102	397
	8	401	71	473	380	76	456	357	83	440	332	92	424	307	103	409
	9	416	72	487	393	77	470	370	84	453	345	92	437	318	103	422
	10	430	72	502	407	77	484	382	84	467	357	93	450	330	104	434
35,2	6	396	76	471	374	81	455	350	88	438	325	98	423	299	109	409
	7	410	76	487	387	82	469	364	89	453	338	98	436	311	110	421
	8	425	77	502	402	82	484	377	90	467	351	99	450	324	111	435
	9	441	78	519	417	83	500	391	90	481	364	100	464	336	112	448
37,2	10	457	78	535	432	84	516	406	91	497	378	101	479	349	113	462
	6	435	82	516	410	87	497	384	95	479	357	105	462	328	117	446
	7	451	82	533	426	88	514	399	96	495	371	106	477	342	118	460
	8	468	83	551	442	89	531	415	97	511	386	107	493	356	119	475
40,2	9	486	84	569	459	89	548	431	97	528	401	108	509	370	120	490
	10	504	84	588	476	90	566	447	98	545	417	109	525	384	121	506
	6	463	88	551	437	93	530	409	102	511	380	112	493	350	126	475
	7	481	88	569	454	94	548	425	103	528	395	113	509	364	127	491
43,2	8	499	89	588	471	95	566	442	103	545	411	114	525	379	128	507
	9	518	90	607	489	96	585	459	104	563	427	115	543	394	129	523
	10	537	90	627	507	97	604	476	105	582	444	116	560	410	130	540
	6	510	92	602	481	98	580	451	107	558	419	118	537	386	132	518
47,2	7	529	93	622	500	99	599	469	108	577	436	119	555	401	133	535
	8	549	93	643	519	100	619	487	109	596	453	120	574	418	134	552
	9	570	94	664	539	101	639	506	110	615	471	121	592	435	136	570
	10	591	95	686	559	102	660	525	111	636	489	122	612	452	137	589
51,2	6	538	98	636	508	105	613	477	114	591	443	126	569	408	140	548
	7	558	99	657	528	106	633	495	115	610	461	127	588	425	141	566
	8	579	100	679	548	106	654	514	116	630	479	128	607	442	142	584
	9	601	100	701	568	107	676	534	117	651	498	129	627	460	144	603
51,2	10	623	101	724	589	108	698	554	118	672	517	130	647	478	145	623
	6	588	110	698	555	117	672	520	128	648	484	141	625	445	157	602
	7	610	111	721	577	118	695	541	129	670	503	142	645	463	158	622
	8	633	112	745	598	119	718	562	130	692	523	143	666	482	160	642
51,2	9	657	113	769	621	120	742	583	131	714	544	145	688	502	161	663
	10	681	113	795	644	121	766	606	132	738	565	146	710	522	163	684
	6	632	108	740	597	116	713	560	126	685	520	139	659	478	155	634
	7	656	109	765	620	116	737	582	127	708	541	140	681	498	157	655
51,2	8	681	110	791	644	117	761	604	128	732	562	141	704	518	158	676
	9	707	111	817	668	118	787	627	129	756	584	143	727	539	159	699
	10	733	112	844	693	119	813	651	130	781	607	144	751	561	161	721

Pf: cooling power [kW]

Pe: electric power absorbed by compressors [kW]

Pr: recovery condenser heat power [kW]

T0: evaporator outlet water temperature [°C] Evaporator thermal gap = 5°C

RECOVERY CAPACITY - KAPPA V EVO

Model	To [°C]	OUTPUT WATER TEMPERATURE FROM CONDENSER [°C]														
		30			35			40			45			50		
		Pf	Pe	Pr	Pf	Pe	Pr	Pf	Pe	Pr	Pf	Pe	Pr	Pf	Pe	Pr
54,2	6	658	124	782	621	133	754	582	145	727	541	160	701	497	179	677
	7	683	125	808	645	134	779	605	146	751	563	161	724	518	181	699
	8	708	126	834	670	135	805	628	147	776	585	163	748	539	182	721
	9	735	127	862	695	136	831	653	148	801	608	164	772	561	184	745
	10	762	128	890	721	137	858	677	150	827	631	166	797	583	185	768
58,2	6	743	138	881	703	147	850	659	160	820	613	177	791	565	199	764
	7	766	139	904	724	148	872	680	162	842	634	179	812	585	200	785
	8	792	140	931	749	149	898	704	163	867	656	180	836	606	202	808
	9	819	141	960	775	151	925	728	164	892	679	182	861	628	203	831
	10	847	142	989	802	152	953	754	165	919	703	183	886	650	205	854
61,2	6	779	135	914	735	144	879	687	157	844	638	173	811	586	194	779
	7	808	136	944	763	145	908	714	158	872	663	175	837	609	195	805
	8	838	137	975	791	146	937	741	159	900	688	176	864	633	197	830
	9	869	138	1007	820	148	967	768	161	929	714	178	891	657	198	856
	10	900	139	1039	849	149	998	796	162	958	740	179	919	682	200	882
67,2	6	824	141	964	777	150	927	727	164	890	674	181	855	619	202	821
	7	855	142	997	806	152	958	754	165	919	700	182	882	643	204	847
	8	886	143	1029	835	153	988	782	166	949	726	184	910	668	206	874
	9	918	144	1062	866	154	1020	811	168	979	753	186	939	694	207	901
	10	950	145	1095	897	155	1052	840	169	1009	781	187	968	720	209	929
70,2	6	884	156	1039	833	166	999	779	181	960	722	200	922	663	224	886
	7	916	157	1073	863	168	1031	808	182	990	750	202	951	689	225	914
	8	949	158	1107	895	169	1064	838	184	1022	778	203	981	715	227	943
	9	983	159	1142	927	170	1097	868	185	1054	807	205	1012	743	229	972
	10	1018	160	1178	960	172	1132	900	187	1087	837	207	1043	771	231	1001
73,2	6	931	156	1087	877	166	1044	821	181	1002	761	200	961	698	224	922
	7	965	157	1122	910	168	1077	851	183	1034	790	202	991	725	226	951
	8	1000	158	1158	943	169	1112	882	184	1066	819	203	1023	753	227	981
	9	1036	159	1195	977	170	1147	915	186	1100	850	205	1055	782	229	1011
	10	1072	160	1233	1011	172	1183	948	187	1135	881	207	1088	811	231	1042
80,2	6	983	177	1160	926	189	1116	866	206	1072	803	228	1031	737	255	991
	7	1019	179	1197	960	191	1151	898	208	1106	833	230	1063	765	257	1022
	8	1055	180	1235	995	192	1187	931	209	1141	865	231	1096	795	259	1054
	9	1093	181	1274	1031	194	1225	965	211	1177	897	233	1130	825	261	1086
	10	1131	183	1314	1067	195	1263	1000	213	1213	930	235	1165	857	263	1120
82,2	6	1005	174	1179	949	186	1135	891	201	1093	829	222	1051	762	248	1010
	7	1041	176	1217	983	188	1171	923	204	1127	858	225	1083	789	251	1040
	8	1077	178	1255	1016	190	1206	954	206	1160	887	227	1114	816	254	1070
	9	1112	180	1292	1049	192	1242	985	209	1194	916	230	1146	843	257	1100
	10	1148	182	1329	1083	194	1277	1017	211	1228	946	233	1179	871	260	1131
85,2	6	1073	182	1255	1012	194	1206	949	210	1160	882	232	1114	810	259	1069
	7	1110	184	1294	1047	196	1244	982	213	1195	912	235	1147	838	262	1100
	8	1147	186	1333	1082	198	1280	1014	215	1230	942	237	1180	866	265	1131
	9	1184	187	1372	1117	201	1317	1047	218	1265	973	240	1213	895	268	1163
	10	1222	189	1411	1152	203	1355	1080	221	1301	1004	243	1248	924	271	1195
90,2	6	1139	199	1338	1074	213	1286	1005	231	1236	933	255	1187	856	284	1140
	7	1177	201	1378	1109	215	1324	1038	234	1272	964	258	1221	884	288	1172
	8	1215	203	1418	1145	218	1362	1072	236	1308	995	261	1255	913	291	1204
	9	1253	205	1459	1181	220	1401	1106	239	1345	1027	264	1290	943	294	1238
	10	1292	207	1500	1217	222	1440	1140	242	1382	1059	267	1326	973	298	1271
95,2	6	1195	212	1408	1131	227	1357	1062	246	1309	988	272	1260	909	304	1214
	7	1238	215	1453	1171	229	1400	1101	249	1350	1024	276	1300	943	309	1252
	8	1281	217	1498	1212	232	1445	1140	253	1393	1061	280	1340	978	313	1290
	9	1326	219	1545	1255	235	1490	1180	256	1436	1098	283	1382	1013	317	1330
	10	1372	222	1593	1298	238	1536	1221	259	1480	1137	287	1424	1050	321	1371

Pf: cooling power [kW]

Pe: electric power absorbed by compressors [kW]

Pr: recovery condenser heat power [kW]

TO: evaporator outlet water temperature [°C] Evaporator thermal gap = 5°C

RECOVERY CAPACITY - KAPPA V EVO

Model	To	OUTPUT WATER TEMPERATURE FROM CONDENSER [°C]														
	[°C]	30			35			40			45			50		
		Pf	Pe	Pr	Pf	Pe	Pr	Pf	Pe	Pr	Pf	Pe	Pr	Pf	Pe	Pr
100,2	6	1219	233	1452	1155	248	1402	1087	268	1354	1015	294	1309	937	328	1265
	7	1263	235	1498	1198	250	1448	1127	271	1398	1054	297	1351	971	333	1303
	8	1311	237	1548	1242	252	1494	1169	273	1443	1094	300	1394	1008	336	1344
	9	1358	239	1597	1287	255	1542	1211	277	1488	1135	303	1438	1047	340	1387
	10	1407	241	1649	1332	258	1589	1255	279	1535	1174	308	1482	1087	343	1430
105,2	6	1303	240	1543	1232	255	1487	1158	275	1433	1077	302	1379	992	336	1328
	7	1349	243	1592	1277	257	1534	1199	277	1477	1116	305	1420	1028	339	1367
	8	1396	245	1640	1321	259	1581	1240	280	1520	1155	308	1463	1064	343	1406
	9	1444	246	1690	1366	262	1627	1282	283	1565	1195	311	1506	1098	347	1445
	10	1494	248	1742	1412	264	1676	1325	286	1611	1233	315	1547	1136	350	1486
110,2	6	1404	242	1646	1330	257	1587	1248	279	1527	1164	306	1471	1074	342	1415
	7	1455	245	1700	1374	261	1635	1294	282	1576	1207	310	1517	1115	346	1461
	8	1503	247	1751	1424	264	1688	1341	285	1626	1252	314	1566	1157	350	1507
	9	1557	250	1807	1475	266	1741	1389	289	1678	1298	318	1615	1200	354	1554
	10	1611	252	1863	1527	269	1796	1438	292	1730	1345	322	1666	1244	359	1603
115,2	6	1477	264	1742	1394	282	1676	1311	305	1616	1222	335	1558	1127	374	1501
	7	1526	268	1794	1445	285	1730	1359	308	1668	1268	339	1607	1170	379	1549
	8	1581	270	1851	1497	288	1785	1409	312	1721	1315	344	1658	1214	383	1597
	9	1637	273	1910	1550	291	1841	1459	316	1775	1363	348	1710	1259	388	1647
	10	1694	276	1970	1605	294	1899	1511	320	1831	1412	352	1764	1305	393	1698
120,2	6	1600	270	1870	1520	288	1809	1435	311	1746	1347	337	1684	1250	368	1618
	7	1653	273	1927	1570	292	1862	1483	315	1797	1391	341	1732	1292	372	1663
	8	1703	278	1982	1621	296	1918	1532	319	1850	1438	344	1782	1335	376	1711
	9	1758	282	2041	1674	300	1974	1581	322	1904	1485	348	1833	1379	380	1759
	10	1814	287	2101	1727	304	2031	1632	327	1959	1533	353	1885	1424	384	1808
130,2	6	1649	296	1946	1569	317	1885	1480	342	1821	1387	370	1757	1287	404	1691
	7	1702	301	2003	1618	321	1939	1528	346	1874	1433	374	1807	1330	409	1738
	8	1758	305	2063	1671	325	1996	1579	350	1928	1480	379	1859	1374	413	1787
	9	1812	310	2122	1724	330	2054	1630	354	1984	1529	383	1912	1420	417	1838
	10	1869	314	2184	1780	334	2114	1683	359	2041	1579	388	1967	1468	422	1890
140,2	6	1731	312	2043	1645	333	1978	1552	359	1911	1446	392	1838	1338	428	1766
	7	1788	316	2104	1693	339	2032	1597	365	1962	1493	396	1890	1383	433	1815
	8	1846	320	2166	1748	343	2091	1648	370	2018	1542	401	1943	1429	437	1866
	9	1898	326	2224	1803	348	2151	1702	374	2076	1593	406	1999	1476	442	1919
	10	1958	331	2290	1862	353	2214	1758	379	2137	1646	411	2057	1526	448	1974

Pf: cooling power [kW]

Pe: electric power absorbed by compressors [kW]

Pr: recovery condenser heat power [kW]

T0: evaporator outlet water temperature [°C] Evaporator thermal gap = 5°C

COOLING CAPACITY - KAPPA V EVO /A

Model	To	EXTERNAL AIR TEMPERATURE [°C]											
	[°C]	25		30		35		40		43		49*	
		Pf	Pe	Pf	Pe	Pf	Pe	Pf	Pe	Pf	Pe	Pf	Pe
23,1	5	266	57	250	62	234	68	217	75	198	84	183	92
	6	274	58	258	63	241	69	224	76	205	85	189	93
	7	283	59	266	64	249	70	231	78	211	87	195	95
	8	291	60	275	65	257	71	238	79	218	88	202	96
	9	300	61	283	66	265	73	246	80	225	90	208	98
23,2	5	258	56	243	59	228	65	211	73	192	85	176	99
	6	265	56	250	60	234	66	217	74	198	87	182	100
	7	274	57	259	61	242	67	224	75	205	88	188	102
	8	283	58	267	62	250	68	232	77	212	89	195	103
	9	292	59	276	63	258	69	239	78	219	91	201	105
25,1	5	303	66	285	72	265	79	244	88	222	99	205	107
	6	313	67	294	73	274	81	252	90	230	101	213	109
	7	323	68	303	74	282	82	261	92	237	103	220	111
	8	332	69	312	76	291	84	269	93	245	105	228	113
	9	342	70	322	77	300	85	277	95	253	107	235	115
25,2	5	308	68	290	73	271	81	250	92	237	101	208	126
	6	317	69	299	75	279	82	258	94	244	103	214	128
	7	327	70	308	76	288	84	266	95	252	104	221	130
	8	338	72	318	77	297	85	275	97	260	106	229	132
	9	348	73	328	79	307	87	283	99	269	108	237	134
28,1	5	329	69	311	74	291	81	270	90	247	101	228	111
	6	339	70	320	75	299	82	278	91	254	102	235	113
	7	350	71	330	77	309	84	287	93	263	104	243	114
	8	361	72	341	78	319	85	296	94	272	106	252	116
	9	372	73	352	79	329	87	306	96	281	107	260	118
28,2	5	331	71	312	76	292	83	270	94	247	110	226	128
	6	340	72	321	77	300	85	278	95	254	111	233	129
	7	351	73	331	79	310	86	287	97	262	113	241	131
	8	362	74	342	80	320	87	297	99	271	115	249	133
	9	374	76	353	81	330	89	306	100	280	117	258	135
31,1	5	358	77	337	83	315	91	292	101	267	113	246	124
	6	367	78	346	84	324	92	300	102	274	114	253	126
	7	379	79	357	85	334	94	309	104	283	116	261	128
	8	392	80	369	87	345	95	319	106	293	118	270	130
	9	404	81	381	88	356	97	330	108	302	120	279	132
31,2	5	359	78	338	84	316	92	292	103	266	118	244	133
	6	369	79	347	85	324	93	300	104	273	119	251	135
	7	381	80	359	87	335	95	310	106	282	121	260	137
	8	393	81	370	88	346	97	320	108	292	123	269	139
	9	405	83	382	90	357	98	330	110	302	125	278	141
33,2	5	387	82	364	88	340	97	315	108	287	121	265	133
	6	397	83	374	90	349	98	323	109	295	123	272	135
	7	410	84	386	91	361	100	334	111	305	125	282	137
	8	423	85	399	92	373	102	345	113	316	127	292	139
	9	437	87	412	94	385	103	356	115	326	129	301	142
35,2	5	419	88	395	95	369	104	342	116	313	130	288	143
	6	431	89	406	96	380	106	352	118	322	132	297	145
	7	445	90	419	98	392	108	364	120	333	134	307	147
	8	459	92	433	100	405	109	376	122	344	136	318	150
	9	474	93	447	101	418	111	388	124	356	138	329	152
37,2	5	452	95	425	102	398	112	368	125	336	140	307	166
	6	464	96	437	104	408	114	378	127	346	142	316	168
	7	479	97	452	105	422	116	391	129	358	144	327	170
	8	495	99	466	107	436	118	404	131	370	147	338	172
	9	511	100	481	109	450	120	417	133	382	149	350	175
	10	527	102	497	111	465	122	430	136	395	152	362	177

(*) For HT version only

Pf: cooling power [kW]

Pe: electric power absorbed by compressors [kW]

Pr: recovery condenser heat power [kW]

T0: evaporator outlet water temperature [°C] Evaporator thermal gap = 5°C

COOLING CAPACITY - KAPPA V EVO /A

Model	To	EXTERNAL AIR TEMPERATURE [°C]											
	[°C]	25		30		35		40		43		49*	
		Pf	Pe	Pf	Pe	Pf	Pe	Pf	Pe	Pf	Pe	Pf	Pe
40,2	5	487	106	458	115	428	126	396	141	361	158	332	174
	6	502	107	473	117	442	129	408	143	373	161	343	177
	7	518	109	488	119	455	131	421	146	385	164	355	180
	8	533	111	502	120	469	133	434	148	397	166	365	183
	9	548	112	516	122	482	135	446	150	408	169	376	186
43,2	5	564	114	531	124	496	137	459	153	420	172	388	189
	6	518	109	488	118	456	129	422	143	386	160	355	176
	7	534	110	503	119	470	131	435	146	398	163	367	179
	8	551	112	519	121	485	133	449	148	411	166	379	182
	9	567	113	534	123	499	135	463	150	424	168	391	185
47,2	5	584	115	550	125	514	138	476	153	436	171	403	188
	6	601	117	566	127	530	140	491	155	450	174	415	190
	7	616	122	582	132	546	144	506	160	464	182	429	199
	8	634	124	599	134	561	147	521	163	478	185	442	203
	9	652	125	616	136	577	149	536	165	493	187	456	206
51,2	5	600	126	566	137	529	150	490	166	448	186	414	205
	6	618	128	583	138	546	152	506	169	463	189	427	208
	7	635	130	599	140	561	154	521	171	478	192	441	211
	8	654	131	617	142	578	156	536	174	492	195	455	215
	9	673	133	635	144	595	159	552	176	507	198	470	218
54,2	5	693	135	654	147	612	161	568	179	522	201	484	221
	6	648	142	610	154	569	169	525	188	478	210	439	232
	7	669	144	630	156	587	172	542	191	495	214	454	236
	8	691	146	650	159	607	175	561	194	512	218	470	240
	9	713	149	672	162	627	178	580	198	529	222	487	244
61,2	5	736	151	693	164	647	181	599	201	547	226	504	248
	6	760	154	715	167	668	184	618	205	565	230	521	252
	7	695	145	653	157	609	173	562	192	512	215	470	237
	8	718	148	675	160	630	176	581	195	530	219	487	241
	9	742	150	698	163	651	179	601	199	549	223	504	245
70,2	5	766	153	721	166	672	182	621	202	567	227	522	249
	6	791	155	744	169	694	185	642	206	586	231	540	254
	7	816	158	767	172	716	189	662	210	605	235	558	258
	8	844	165	793	178	744	196	691	217	635	243	588	268
	9	868	167	815	181	769	199	719	221	663	247	616	272
73,2	5	893	177	838	193	780	212	720	235	657	263	604	289
	6	817	171	767	186	714	204	658	227	598	255	548	280
	7	844	174	793	189	738	208	681	231	620	259	568	285
	8	872	177	819	193	763	212	704	236	641	264	588	290
	9	900	180	845	196	788	216	727	240	662	269	608	295
80,2	5	928	183	872	200	812	220	749	244	683	273	628	300
	6	956	186	898	203	837	224	772	249	704	278	648	305
	7	870	187	816	203	759	224	697	249	633	279	578	307
	8	899	190	843	207	784	228	721	253	654	284	599	312
	9	928	193	871	211	809	232	744	258	676	289	619	318
82,2	5	956	196	896	214	833	236	766	263	697	294	638	323
	6	984	200	922	218	857	240	789	267	717	299	657	329
	7	1012	203	948	222	881	245	811	272	738	304	677	334
	8	895	186	840	202	781	222	719	247	653	276	598	304
	9	924	189	868	205	807	226	743	251	676	281	620	310
85,2	5	955	192	896	209	834	230	768	256	699	287	641	315
	6	985	195	925	213	861	234	794	261	723	292	663	321
	7	1016	199	954	216	888	239	819	265	746	297	685	326
	8	1048	202	984	220	916	243	845	270	770	303	708	332
	9	955	205	895	223	831	245	763	273	691	307	631	338
85,2	6	986	208	924	227	858	250	788	279	715	312	653	344
	7	1018	212	954	231	886	255	814	284	738	318	675	350
	8	1050	216	983	235	913	260	839	289	762	324	697	356
	9	1081	219	1013	240	940	265	864	294	785	330	718	362
	10	1113	223	1042	244	968	270	890	300	808	336	740	369

(*) For HT version only

Pf: cooling power [kW]

Pe: electric power absorbed by compressors [kW]

Pr: recovery condenser heat power [kW]

T0: evaporator outlet water temperature [°C] Evaporator thermal gap = 5°C

COOLING CAPACITY - KAPPA V EVO /A

Model	To	EXTERNAL AIR TEMPERATURE [°C]											
	[°C]	25		30		35		40		43		49*	
		Pf	Pe	Pf	Pe	Pf	Pe	Pf	Pe	Pf	Pe	Pf	Pe
90,2	5	1021	219	958	238	891	261	820	290	744	325	680	357
	6	1054	223	989	242	919	266	846	296	768	331	703	364
	7	1086	227	1019	246	947	271	871	301	792	337	725	370
	8	1118	230	1048	251	975	276	897	306	815	342	747	376
	9	1150	234	1078	255	1003	281	923	312	839	348	769	382
95,2	5	1086	229	1018	249	946	273	870	304	789	341	721	375
	6	1120	233	1050	253	975	278	896	309	814	346	744	381
	7	1153	237	1081	257	1004	283	923	314	838	352	767	387
	8	1187	240	1112	262	1033	288	950	320	863	358	790	393
	9	1220	244	1144	266	1063	293	977	325	888	364	814	400
100,2	5	1146	246	1075	267	999	294	919	328	913	370	837	406
	6	1183	250	1110	272	1032	300	949	334	933	376	857	412
	7	1221	254	1145	278	1065	306	980	340	959	381	881	419
	8	1259	259	1181	283	1098	312	1011	347	979	389	901	427
	9	1297	264	1217	288	1132	318	1042	354	1008	396	926	435
105,2	5	1146	246	1075	267	999	294	919	328	833	367	761	404
	6	1183	250	1110	272	1032	300	949	334	861	374	788	412
	7	1221	254	1145	278	1065	306	980	340	890	381	814	419
	8	1259	259	1181	283	1098	312	1011	347	919	389	841	427
	9	1297	264	1217	288	1132	318	1042	354	948	396	868	435
110,2	5	1256	257	1181	280	1101	309	1015	344	925	386	849	425
	6	1292	261	1214	284	1132	314	1045	350	952	393	874	432
	8	1330	265	1250	289	1166	320	1076	356	981	400	902	440
	9	1369	269	1287	294	1200	325	1108	363	1011	407	930	447
	10	1408	274	1324	300	1235	331	1140	369	1041	414	958	455
115,2	5	1344	288	1261	315	1172	348	1078	388	978	437	894	482
	6	1383	292	1297	320	1206	354	1110	395	1007	444	921	490
	7	1421	297	1333	325	1240	360	1141	402	1036	452	948	498
	8	1463	302	1372	331	1277	367	1175	409	1068	460	978	506
	9	1504	308	1412	337	1313	373	1209	417	1100	468	1007	515
120,2	5	1547	313	1451	343	1350	380	1244	425	1132	477	1037	524
	6	1430	322	1368	356	1302	393	1230	435	1152	483	1086	526
	7	1469	326	1406	360	1338	398	1264	440	1185	488	1117	531
	8	1509	330	1444	364	1374	402	1298	445	1217	493	1147	536
	9	1552	334	1485	369	1413	407	1335	450	1252	498	1181	542
130,2	5	1595	339	1527	373	1453	412	1373	455	1287	504	1214	548
	6	1639	343	1569	378	1493	417	1411	460	1323	510	1248	554
	7	1674	348	1612	383	1534	422	1450	465	1359	516	1282	560
	8	1719	353	1657	388	1576	427	1491	470	1400	522	1317	566
	9	1765	358	1703	393	1619	432	1534	475	1443	528	1353	572
140,2	5	1790	363	1749	398	1663	437	1580	480	1488	534	1390	578
	6	1839	368	1799	403	1706	442	1623	485	1533	540	1437	584
	7	1889	373	1850	408	1750	447	1667	490	1578	546	1484	590
	8	1940	378	1902	413	1800	452	1713	495	1625	552	1532	596
	9	1992	383	1955	418	1845	457	1759	500	1673	558	1581	602
150,4	5	1516	334	1453	370	1385	409	1312	453	1234	503	1169	547
	6	1558	338	1493	374	1423	414	1348	458	1268	507	1200	551
	7	1600	342	1533	378	1461	418	1384	462	1302	512	1232	556
	8	1645	347	1577	383	1502	423	1423	467	1338	517	1267	561
	9	1691	351	1621	388	1544	428	1463	473	1376	522	1302	566

(*) For HT version only

Pf: cooling power [kW]

Pe: electric power absorbed by compressors [kW]

Pr: recovery condenser heat power [kW]

T0: evaporator outlet water temperature [°C] Evaporator thermal gap = 5°C

HEATING CAPACITY - KAPPA V EVO /A

Model	INPUT WATER TEMPERATURE TO CONDENSER [°C]									
	Ta [°C]	RH %	30/35		35/40		40/45		45/50	
			Pt	Pe	Pt	Pe	Pt	Pe	Pt	Pe
23,1	-8	95	167	46	165	49	164	55	163	61
	-5	90	183	47	181	51	178	56	177	63
	0	80	211	50	208	54	206	59	203	67
	5	80	238	52	237	56	236	63	233	70
	7	70	245	52	241	57	238	63	235	70
10	70	266	54	261	58	256	65	253	72	
23,2	-8	95	160	44	157	47	157	54	160	64
	-5	90	173	45	171	49	170	55	172	65
	0	80	198	47	196	51	194	57	195	67
	5	80	226	50	222	54	224	60	224	70
	7	70	236	51	231	54	228	61	228	70
10	70	254	52	249	56	246	63	245	72	
25,1	-8	95	188	52	185	56	183	63	182	71
	-5	90	206	54	203	58	200	65	199	73
	0	80	236	56	233	61	230	68	228	76
	5	80	270	59	266	64	262	71	260	80
	7	70	281	59	277	65	273	72	270	81
10	70	304	61	297	66	293	73	290	83	
25,2	-8	95	191	53	188	57	188	64	192	77
	-5	90	207	54	205	58	204	66	206	78
	0	80	238	57	235	61	233	68	235	80
	5	80	270	60	266	64	264	72	265	84
	7	70	273	60	271	65	271	72	272	84
10	70	293	62	286	66	286	74	284	86	
28,1	-8	95	207	57	209	62	201	68	204	78
	-5	90	230	59	227	64	224	71	222	80
	0	80	265	62	261	67	257	74	255	83
	5	80	302	65	297	70	293	78	291	88
	7	70	313	66	307	71	303	79	301	89
10	70	331	67	328	73	325	82	322	92	
28,2	-8	95	212	58	209	62	203	70	211	84
	-5	90	229	59	226	64	225	72	228	85
	0	80	264	63	260	67	258	75	258	88
	5	80	302	66	297	71	293	79	293	92
	7	70	312	67	306	72	302	80	302	93
10	70	328	68	325	74	323	82	323	95	
31,1	-8	95	220	61	216	66	213	73	212	82
	-5	90	243	63	239	68	235	75	234	84
	0	80	281	65	276	71	272	78	274	89
	5	80	321	69	318	75	312	82	312	93
	7	70	335	70	330	76	325	84	323	94
10	70	358	71	353	78	348	86	345	97	
31,2	-8	95	224	62	221	67	219	75	221	86
	-5	90	244	64	241	69	239	77	241	88
	0	80	282	67	278	72	275	80	274	92
	5	80	322	71	317	76	314	85	313	97
	7	70	334	72	329	77	325	86	324	98
10	70	355	73	350	79	347	88	347	100	
33,2	-8	95	245	67	243	73	242	81	242	91
	-5	90	267	69	265	75	261	83	260	93
	0	80	306	72	302	78	300	87	298	97
	5	80	346	75	344	82	341	91	339	102
	7	70	350	75	345	82	343	91	343	102
10	70	379	78	373	84	368	93	366	105	
35,2	-8	95	257	72	253	77	250	86	250	97
	-5	90	282	74	277	80	274	89	272	100
	0	80	327	78	322	84	318	93	315	105
	5	80	370	81	364	88	359	98	356	110
	7	70	386	82	380	89	375	99	370	112
10	70	415	84	409	92	403	102	398	115	
37,2	-8	95	267	75	263	81	261	90	261	102
	-5	90	293	78	289	84	286	93	284	105
	0	80	341	82	336	89	333	98	330	111
	5	80	384	85	379	92	374	102	371	115
	7	70	401	86	395	94	390	104	387	117
10	70	434	88	425	96	419	107	415	120	

Pt: heat power [kW]

Pe: power absorbed by compressors [kW]

Ta: Dry bulb temperature of the evaporator inlet air [°C]

RH: relative humidity of the input air at the evaporator [%]

HEATING CAPACITY - KAPPA V EVO /A

Model	INPUT WATER TEMPERATURE TO CONDENSER [°C]									
	Ta [°C]	RH %	30/35		35/40		40/45		45/50	
			Pt	Pe	Pt	Pe	Pt	Pe	Pt	Pe
40,2	-8	95	297	82	294	89	292	99	291	112
	-5	90	325	85	319	92	316	102	313	115
	0	80	373	89	368	97	364	108	361	121
	5	80	413	92	407	100	402	111	400	125
	7	70	432	93	425	102	420	113	417	127
43,2	10	70	468	96	460	104	452	116	448	130
	-8	95	313	87	308	93	305	103	303	116
	-5	90	344	89	338	97	334	107	331	120
	0	80	396	94	389	102	384	112	381	126
	5	80	451	98	444	107	438	118	434	133
47,2	7	70	471	100	463	108	457	120	451	135
	10	70	508	102	499	111	491	123	485	138
	-8	95	350	97	338	104	335	115	338	130
	-5	90	377	100	372	108	367	119	364	134
	0	80	433	105	427	113	422	125	418	141
51,2	5	80	493	109	487	119	483	132	478	148
	7	70	511	111	506	120	499	133	494	150
	10	70	547	113	538	123	531	136	527	153
	-8	95	372	103	366	111	364	123	363	139
	-5	90	405	106	400	115	396	127	393	143
54,2	0	80	465	111	459	120	455	133	452	150
	5	80	515	115	513	125	511	139	511	157
	7	70	534	116	526	126	520	140	517	157
	10	70	578	119	569	130	562	144	555	161
	-8	95	403	113	399	122	396	135	395	152
57,2	-5	90	440	116	434	125	428	139	425	156
	0	80	500	121	495	131	491	145	488	163
	5	80	561	126	559	137	555	152	553	172
	7	70	565	126	562	137	560	153	560	172
	10	70	609	130	601	141	597	157	592	176
61,2	-8	95	417	118	412	128	409	142	409	161
	-5	90	452	121	447	132	444	146	443	165
	0	80	521	127	515	138	511	153	509	173
	5	80	592	132	582	144	576	160	572	181
	7	70	616	134	607	146	601	162	597	183
65,2	10	70	668	138	657	150	648	167	642	188
	-8	95	487	134	482	145	478	162	477	183
	-5	90	527	137	521	149	517	166	516	188
	0	80	616	145	608	157	602	175	597	197
	5	80	688	150	677	163	669	181	663	205
69,2	7	70	719	152	707	166	699	184	692	208
	10	70	778	156	765	170	753	189	744	214
	-8	95	495	137	488	148	485	165	484	187
	-5	90	536	140	530	152	526	169	524	192
	0	80	624	147	616	161	611	179	607	202
73,2	5	80	697	153	685	167	678	185	673	209
	7	70	726	155	715	169	707	188	702	213
	10	70	788	159	774	174	764	193	756	218
	-8	95	533	146	527	158	523	176	519	199
	-5	90	577	149	570	162	566	180	563	204
77,2	0	80	663	156	655	170	650	189	647	214
	5	80	736	162	725	176	716	195	715	221
	7	70	761	164	749	178	742	198	737	224
	10	70	826	168	814	183	802	203	795	230

Pt: heat power [kW]

Pe: power absorbed by compressors [kW]

Ta: Dry bulb temperature of the evaporator inlet air [°C]

RH: relative humidity of the input air at the evaporator [%]

COOLING CAPACITY - KAPPA V EVO /A SLN

Model	To	EXTERNAL AIR TEMPERATURE [°C]											
	[°C]	25		30		35		40		43		49*	
		Pf	Pe	Pf	Pe	Pf	Pe	Pf	Pe	Pf	Pe	Pf	Pe
23,1	5	260	59	244	65	228	71	210	79	199	84	175	96
	6	268	60	252	66	235	72	217	80	205	86	181	98
	7	276	61	260	67	242	74	223	82	212	87	187	100
	8	285	62	267	68	249	75	230	83	218	89	193	101
	9	293	63	275	69	257	76	237	85	225	90	199	103
23,2	5	252	57	237	61	221	68	203	77	192	85	167	108
	6	259	57	243	62	227	69	209	79	197	87	172	109
	7	267	58	251	63	234	70	216	80	204	88	178	111
	8	275	59	259	64	241	71	223	82	210	90	184	113
	9	284	60	267	66	249	73	230	83	217	91	190	115
25,1	5	298	68	279	74	259	82	238	92	224	99	196	114
	6	308	69	288	75	268	83	246	93	232	100	202	116
	7	317	70	297	77	276	85	253	95	239	102	209	119
	8	327	71	306	78	284	87	261	97	247	104	216	121
	9	337	72	316	79	293	88	269	99	254	106	223	123
25,2	5	299	70	281	75	261	84	239	97	226	107	195	136
	6	308	71	289	77	268	85	246	98	232	109	201	138
	7	317	72	298	78	277	87	255	100	240	111	208	140
	8	327	73	307	79	286	89	263	102	248	112	216	142
	9	338	74	317	81	295	90	271	104	256	115	223	144
28,1	5	321	71	302	78	282	85	260	95	247	101	218	117
	6	330	72	310	79	290	86	268	96	254	103	225	119
	7	340	74	320	80	299	88	276	98	262	105	232	121
	8	351	75	330	81	308	90	285	100	271	107	240	123
	9	362	76	341	83	318	91	294	101	279	109	248	125
28,2	5	324	74	305	80	285	88	262	100	248	111	216	140
	6	333	75	314	81	293	89	270	102	255	112	222	142
	7	344	76	324	82	302	91	278	104	263	114	230	144
	8	355	77	334	84	312	93	287	106	272	116	238	146
	9	366	79	344	85	321	94	297	108	281	118	246	148
31,1	5	350	79	329	86	306	94	282	105	267	113	235	130
	6	359	80	337	87	314	96	290	107	274	114	242	132
	7	370	81	348	88	324	98	299	109	283	116	250	134
	8	381	83	358	90	334	99	308	111	292	119	258	137
	9	393	84	369	92	344	101	318	113	301	121	266	139
31,2	5	351	81	330	87	307	96	282	109	266	118	233	143
	6	360	82	338	89	315	98	290	110	274	120	239	145
	7	372	83	349	90	325	100	299	113	282	122	247	147
	8	384	85	360	92	335	102	309	115	291	124	255	149
	9	395	86	371	94	346	104	318	117	301	127	264	152
33,2	5	379	85	356	92	331	102	305	113	288	122	254	140
	6	389	86	365	93	340	103	313	115	296	123	261	143
	7	401	87	377	95	351	105	323	117	306	126	270	145
	8	414	89	389	97	362	107	334	119	316	128	279	148
	9	427	90	401	99	373	109	344	122	326	130	288	150
35,2	5	410	91	386	99	360	109	332	122	314	130	277	151
	6	422	93	397	101	370	111	341	124	323	132	285	153
	7	436	94	410	102	382	113	353	126	334	135	295	156
	8	450	96	423	104	394	115	364	128	345	137	305	158
	9	464	97	436	106	407	117	376	131	356	140	316	161
37,2	5	441	98	414	107	386	118	355	132	336	141	290	182
	6	453	100	426	109	396	120	365	134	345	143	299	184
	7	468	101	439	110	409	122	377	136	357	146	309	187
	8	483	103	453	112	422	124	389	139	369	149	320	190
	9	498	105	467	115	435	127	402	141	380	151	330	192
	10	513	107	482	117	449	129	414	144	393	154	341	195

(*) For HT version only

Pf: cooling power [kW]

Pe: electric power absorbed by compressors [kW]

Pr: recovery condenser heat power [kW]

T0: evaporator outlet water temperature [°C] Evaporator thermal gap = 5°C

COOLING CAPACITY - KAPPA V EVO /A SLN

Model	To	EXTERNAL AIR TEMPERATURE [°C]											
	[°C]	25		30		35		40		43		49*	
		Pf	Pe	Pf	Pe	Pf	Pe	Pf	Pe	Pf	Pe	Pf	Pe
40,2	5	485	106	456	116	425	128	392	142	371	153	328	177
	6	500	108	470	117	438	130	404	145	383	155	338	180
	7	516	109	485	119	452	132	417	147	395	158	349	183
	8	531	111	499	121	465	134	429	150	407	161	360	186
	9	546	113	513	123	478	136	442	152	419	163	371	189
43,2	5	561	115	528	125	492	139	454	155	431	166	382	192
	6	505	114	474	124	441	137	407	153	385	163	338	188
	7	521	116	489	126	455	139	419	155	397	166	349	192
	8	536	118	504	129	469	142	432	158	409	169	361	195
	9	552	120	518	131	483	144	445	161	421	172	372	198
47,2	5	568	122	533	133	496	147	458	164	433	175	383	201
	6	584	124	548	135	510	150	471	167	446	178	394	205
	7	552	127	519	138	484	152	447	169	423	180	374	208
	8	569	129	535	140	499	154	461	172	437	183	386	211
	9	586	131	551	142	514	157	475	175	450	187	398	215
51,2	5	603	133	567	145	529	160	489	178	463	190	410	218
	6	620	135	583	148	544	163	503	181	477	193	422	222
	7	637	138	600	150	560	166	517	184	491	197	435	226
	8	587	131	552	142	514	157	474	175	449	187	397	217
	9	604	133	569	145	530	160	489	178	463	191	409	220
54,2	5	621	135	584	147	545	162	504	181	477	194	422	224
	6	639	137	601	149	561	165	519	184	492	197	435	228
	7	657	139	618	152	577	168	534	187	506	200	449	231
	8	676	141	636	154	593	170	549	190	521	204	462	235
	9	637	150	598	163	555	180	510	201	481	216	421	250
57,2	5	656	152	614	166	571	183	524	205	495	219	434	254
	6	676	155	634	169	589	187	541	209	511	224	448	259
	7	698	158	654	172	608	191	558	213	527	228	462	263
	8	719	161	674	176	627	195	576	217	544	233	478	268
	9	741	164	695	179	646	199	594	221	561	237	493	274
61,2	5	686	156	642	171	595	189	545	211	514	226	448	261
	6	708	159	663	174	614	193	563	215	531	230	463	266
	7	731	162	684	178	634	197	581	219	548	235	479	271
	8	753	165	705	181	654	201	600	224	566	240	495	276
	9	777	169	727	185	674	205	619	228	584	245	511	282
65,2	5	800	172	749	189	695	209	638	233	603	250	528	288
	6	758	176	709	192	657	212	603	236	568	253	496	292
	7	783	179	732	195	679	216	623	240	587	258	513	297
	8	808	182	756	199	701	220	643	245	607	263	531	303
	9	832	185	778	203	722	224	662	250	625	267	547	308
69,2	5	856	189	801	207	742	228	681	254	643	272	563	313
	6	880	192	823	210	763	232	700	259	661	277	579	319
	7	806	183	754	200	698	221	639	247	602	265	525	305
	8	832	187	778	204	721	226	660	252	622	270	543	311
	9	858	190	803	208	744	231	682	257	643	275	561	317
73,2	5	885	194	828	213	767	235	703	262	663	281	580	324
	6	911	198	853	217	790	240	725	268	684	287	598	330
	7	938	202	878	221	814	245	747	273	705	292	617	336
	8	864	195	807	214	747	236	683	264	644	283	560	327
	9	892	199	833	218	771	241	706	269	665	288	579	333
77,2	5	920	203	860	222	796	246	729	274	687	294	599	339
	6	947	207	885	227	819	251	750	280	707	300	617	345
	7	974	210	910	231	842	256	771	285	727	305	635	352
	8	1001	214	935	235	865	260	793	290	747	311	653	358
	9	946	211	886	230	821	254	753	283	710	303	620	349
81,2	5	976	215	914	235	848	259	778	289	734	309	641	356
	6	1007	219	943	240	875	265	803	294	758	315	663	363
	7	1038	224	972	244	902	270	828	300	782	321	684	370
	8	1069	228	1001	249	929	275	853	307	806	328	706	377
	9	1101	233	1031	255	956	281	878	313	830	334	727	384
85,2	5	1002	234	936	256	866	283	792	315	746	338	647	389
	6	1034	239	966	261	894	289	818	322	770	345	669	397
	7	1066	244	996	267	922	295	844	329	795	352	691	405
	8	1097	249	1026	272	950	301	869	336	819	359	713	413
	9	1129	254	1055	278	977	308	894	342	842	366	734	421
90,2	5	1161	259	1084	284	1004	314	919	349	866	373	755	429

(*) For HT version only

Pf: cooling power [kW]

Pe: electric power absorbed by compressors [kW]

Pr: recovery condenser heat power [kW]

T0: evaporator outlet water temperature [°C] Evaporator thermal gap = 5°C

COOLING CAPACITY - KAPPA V EVO /A SLN

Model	To	EXTERNAL AIR TEMPERATURE [°C]											
	[°C]	25		30		35		40		43		49*	
		Pf	Pe	Pf	Pe	Pf	Pe	Pf	Pe	Pf	Pe	Pf	Pe
95,2	5	1072	245	1001	268	926	296	846	330	796	354	691	408
	6	1105	249	1032	273	954	302	872	336	821	360	713	416
	7	1138	254	1062	278	982	308	898	343	845	367	735	423
	8	1170	259	1092	283	1010	313	923	349	869	374	756	431
	9	1202	264	1122	289	1037	319	948	356	893	381	778	439
100,2	5	1234	269	1152	294	1065	326	974	363	917	388	799	447
	6	1128	253	1055	277	976	306	894	342	842	366	733	423
	7	1201	263	1123	288	1040	319	953	356	898	381	783	440
	8	1237	268	1157	294	1072	325	982	363	926	389	809	448
	9	1274	273	1191	300	1103	332	1011	370	954	396	834	456
105,2	5	1310	279	1224	306	1134	338	1040	377	981	404	858	465
	6	1204	273	1127	299	1045	332	957	371	902	397	786	460
	7	1238	277	1159	305	1074	338	985	377	929	405	810	468
	8	1272	282	1191	310	1104	344	1012	384	955	412	834	476
	9	1308	288	1225	316	1136	351	1042	392	983	420	859	485
115,2	5	1345	293	1259	322	1168	358	1071	400	1011	428	884	494
	6	1382	299	1293	329	1200	365	1101	408	1039	437	910	503
	7	1326	305	1239	336	1147	373	1049	417	987	448	857	519
	8	1363	311	1274	342	1179	380	1078	425	1015	456	882	528
	9	1400	316	1308	348	1211	387	1108	433	1043	465	907	538
120,2	5	1439	323	1345	355	1245	395	1140	442	1074	474	934	548
	6	1479	329	1382	362	1280	403	1172	451	1104	483	961	558
	7	1519	335	1420	370	1315	411	1204	460	1135	493	989	569
	8	1415	335	1351	371	1281	410	1206	455	1158	485	1056	551
	9	1454	340	1388	375	1316	415	1239	460	1190	490	1086	557
130,2	5	1492	344	1425	380	1351	420	1272	465	1222	495	1115	563
	6	1534	349	1464	385	1389	425	1308	471	1256	501	1146	569
	7	1577	354	1505	390	1427	431	1344	477	1291	507	1178	576
	8	1620	359	1545	395	1466	437	1380	483	1326	514	1210	583
	9	1448	349	1382	386	1311	427	1235	473	1187	504	1085	572
140,2	5	1487	353	1420	390	1347	432	1269	478	1219	509	1115	578
	6	1526	358	1457	395	1382	437	1302	484	1251	515	1144	584
	7	1569	363	1497	401	1420	443	1338	490	1286	521	1175	590
	8	1612	368	1538	406	1459	448	1374	496	1321	527	1207	596
	9	1655	374	1579	412	1498	454	1411	502	1356	533	1239	603
140,2	5	1477	362	1411	400	1339	443	1262	491	1214	523	1112	593
	6	1517	367	1448	406	1374	449	1296	497	1246	528	1141	599
	7	1557	372	1486	411	1410	454	1329	502	1278	534	1170	604
	8	1600	377	1527	417	1449	460	1365	508	1313	540	1202	610
	9	1643	383	1568	422	1488	466	1402	514	1348	546	1234	617
	10	1687	389	1610	428	1527	472	1438	521	1383	553	1266	623

(*) For HT version only

Pf: cooling power [kW]

Pe: electric power absorbed by compressors [kW]

Pr: recovery condenser heat power [kW]

T0: evaporator outlet water temperature [°C] Evaporator thermal gap = 5°C

HEATING CAPACITY - KAPPA V EVO /A SLN

Model	INPUT WATER TEMPERATURE TO CONDENSER [°C]									
	Ta [°C]	RH %	30/35		35/40		40/45		45/50	
			Pt	Pe	Pt	Pe	Pt	Pe	Pt	Pe
23,1	-8	95	161	45	158	49	157	54	156	61
	-5	90	173	47	171	50	170	56	169	63
	0	90	203	49	202	53	200	59	199	66
	5	70	225	51	222	55	218	61	217	69
	7	70	238	52	234	56	231	62	229	70
23,2	10	70	258	53	254	58	250	64	247	72
	-8	95	153	44	151	47	151	53	155	64
	-5	90	167	45	164	48	164	54	167	65
	0	90	195	47	191	51	190	57	192	67
	5	70	217	49	213	53	211	59	212	69
25,1	7	70	229	50	225	54	223	60	223	70
	10	70	248	52	243	56	240	62	239	72
	-8	95	182	51	179	55	178	62	178	70
	-5	90	199	53	197	57	195	63	194	72
	0	90	232	55	229	60	226	67	225	75
25,2	5	70	256	57	251	62	248	69	247	78
	7	70	269	58	266	63	263	70	261	79
	10	70	291	59	287	65	283	72	279	81
	-8	95	178	51	176	56	176	63	181	76
	-5	90	194	53	192	57	192	64	196	77
28,1	0	90	222	55	219	60	218	67	221	79
	5	70	255	58	249	63	248	70	250	82
	7	70	262	59	259	64	257	71	259	83
	10	70	283	61	279	66	277	73	278	85
	-8	95	205	57	203	61	201	68	199	77
28,2	-5	90	224	58	221	63	218	70	216	79
	0	90	262	61	257	66	253	73	252	83
	5	70	285	63	281	68	279	76	277	85
	7	70	302	64	298	70	295	78	293	87
	10	70	320	66	317	72	311	79	310	90
31,1	-8	95	207	58	204	62	204	71	208	84
	-5	90	226	59	222	64	221	72	224	85
	0	90	263	63	259	67	256	75	258	88
	5	70	287	65	283	70	282	78	284	91
	7	70	304	66	300	71	297	80	297	92
31,2	10	70	321	68	317	73	315	81	315	94
	-8	95	223	62	215	66	212	73	216	83
	-5	90	240	63	239	69	233	76	234	86
	0	90	279	66	276	72	272	79	270	89
	5	70	307	68	304	74	301	82	299	93
33,2	7	70	326	70	322	76	319	84	317	95
	10	70	350	72	347	78	341	86	338	97
	-8	95	219	62	216	66	215	74	217	86
	-5	90	240	64	236	68	234	76	236	88
	0	90	279	67	274	72	273	80	273	92
35,2	5	70	305	69	301	75	299	83	300	95
	7	70	322	71	319	77	317	85	317	97
	10	70	344	72	341	79	337	87	336	99
	-8	95	235	66	233	71	231	79	232	89
	-5	90	254	68	252	73	251	81	252	92
37,2	0	90	297	71	296	77	295	86	294	96
	5	70	323	73	320	79	315	88	316	99
	7	70	340	74	336	81	333	89	332	101
	10	70	369	76	364	83	359	92	357	104
	-8	95	252	71	249	77	246	85	246	96
37,2	-5	90	277	73	272	79	270	88	268	99
	0	90	322	77	318	84	315	93	312	105
	5	70	356	80	351	87	347	96	345	108
	7	70	378	81	372	88	368	98	364	111
	10	70	408	83	402	91	395	101	391	113
37,2	-8	95	263	75	259	81	257	90	257	102
	-5	90	288	77	284	84	281	93	281	105
	0	90	337	82	333	89	330	98	328	111
	5	70	372	84	365	91	361	101	359	114
	7	70	392	86	387	93	382	104	380	117
10	70	424	88	418	96	413	106	408	120	

Pt: heat power [kW]

Pe: power absorbed by compressors [kW]

Ta: Dry bulb temperature of the evaporator inlet air [°C]

RH: relative humidity of the input air at the evaporator [%]

HEATING CAPACITY - KAPPA V EVO /A SLN

Model	INPUT WATER TEMPERATURE TO CONDENSER [°C]									
	Ta [°C]	RH %	30/35		35/40		40/45		45/50	
			Pt	Pe	Pt	Pe	Pt	Pe	Pt	Pe
40,2	-8	95	297	82	292	89	290	98	288	111
	-5	90	325	85	320	91	317	101	315	114
	0	90	378	89	373	96	368	107	365	120
	5	70	421	92	413	100	408	111	404	124
	7	70	444	94	437	102	432	113	427	127
10	70	480	96	472	104	464	116	459	130	
43,2	-8	95	306	86	301	93	299	102	298	115
	-5	90	335	89	330	96	327	106	325	119
	0	90	389	93	384	101	380	112	377	126
	5	70	433	97	426	105	421	116	418	131
	7	70	456	99	450	107	445	119	441	133
10	70	494	101	486	110	479	122	474	137	
47,2	-8	95	343	96	339	104	330	114	330	129
	-5	90	372	99	366	107	363	118	360	133
	0	90	432	104	426	113	422	125	419	141
	5	70	474	108	465	117	462	130	460	146
	7	70	495	110	492	119	489	132	487	149
10	70	524	112	525	122	522	135	515	152	
51,2	-8	95	357	102	351	110	350	122	350	138
	-5	90	382	104	379	113	378	125	377	141
	0	90	453	110	448	120	445	132	444	149
	5	70	492	113	485	123	480	136	476	153
	7	70	518	115	511	125	506	139	503	156
10	70	562	118	554	129	546	142	542	160	
54,2	-8	95	388	111	381	120	378	133	377	150
	-5	90	415	114	412	123	411	137	411	154
	0	90	486	120	482	130	480	144	480	162
	5	70	524	123	512	133	514	148	509	166
	7	70	547	125	539	135	534	150	533	169
10	70	591	128	584	139	579	155	575	174	
61,2	-8	95	394	116	390	125	388	139	389	158
	-5	90	430	119	425	129	423	144	424	163
	0	90	498	125	492	136	489	151	489	171
	5	70	560	130	550	141	544	157	541	177
	7	70	585	132	577	143	572	160	571	180
10	70	633	135	625	148	620	164	615	185	
70,2	-8	95	455	131	451	142	445	157	445	178
	-5	90	498	134	491	146	487	162	486	183
	0	90	589	142	581	154	576	172	574	194
	5	70	646	146	637	159	628	177	623	200
	7	70	681	149	671	162	663	180	659	204
10	70	739	153	728	167	718	185	710	209	
73,2	-8	95	476	135	469	146	467	163	465	184
	-5	90	516	139	510	150	507	167	507	190
	0	90	610	146	603	159	599	177	597	201
	5	70	671	151	662	165	654	183	649	207
	7	70	705	154	695	167	688	186	684	211
10	70	764	158	754	172	745	192	739	217	
80,2	-8	95	497	143	490	155	488	172	489	195
	-5	90	540	147	534	159	531	177	532	201
	0	90	627	154	618	167	614	186	613	210
	5	70	701	160	691	174	684	193	682	218
	7	70	734	162	722	176	716	196	714	222
10	70	790	166	781	181	775	202	772	228	

Pt: heat power [kW]

Pe: power absorbed by compressors [kW]

Ta: Dry bulb temperature of the evaporator inlet air [°C]

RH: relative humidity of the input air at the evaporator [%]

RECOVERY CAPACITY - KAPPA V EVO /A

Model	To	OUTPUT WATER TEMPERATURE FROM CONDENSER [°C]														
	[°C]	35			40			45			50			55 *		
		Pf	Pe	Pr	Pf	Pe	Pr	Pf	Pe	Pr	Pf	Pe	Pr	Pf	Pe	Pr
23,1	6	279	57	335	261	62	323	243	68	311	224	76	300	204	85	289
	7	289	57	346	271	62	333	252	69	321	232	76	309	212	86	297
	8	299	58	357	281	63	344	262	69	331	241	77	318	220	86	307
	9	310	58	368	291	63	354	271	70	341	250	78	328	229	87	316
	10	321	59	379	301	64	365	281	70	351	260	78	338	238	88	325
23,2	6	267	55	322	250	59	310	233	66	299	214	75	289	195	88	283
	7	277	56	333	260	60	320	242	66	308	223	75	298	203	88	291
	8	288	56	344	270	61	331	251	67	318	232	76	308	212	88	300
	9	298	56	355	280	61	341	261	67	328	241	76	317	220	89	309
	10	309	57	366	291	62	352	271	68	339	251	77	327	229	89	318
25,1	6	327	62	389	307	68	375	286	75	360	263	84	347	239	95	334
	7	339	63	402	318	68	387	296	76	372	273	85	358	249	95	345
	8	351	63	414	330	69	399	307	76	384	284	85	369	259	96	355
	9	364	64	427	342	69	411	319	77	396	295	86	380	269	97	366
	10	377	64	441	354	70	424	330	77	408	306	87	392	280	97	377
25,2	6	332	65	397	311	70	381	289	77	367	266	88	354	242	103	345
	7	344	66	410	323	71	394	301	78	379	277	89	366	252	104	356
	8	357	66	423	335	71	407	312	79	391	288	89	377	263	104	367
	9	370	67	437	348	72	420	324	79	404	299	90	389	273	104	378
	10	384	67	451	361	73	434	336	80	417	311	90	401	284	105	389
28,1	6	343	68	412	322	74	396	299	82	381	275	92	367	250	104	354
	7	356	69	425	334	75	409	310	83	393	286	93	379	260	105	365
	8	369	69	439	346	76	422	322	84	406	297	94	391	271	106	377
	9	383	70	453	359	76	436	335	84	419	309	94	403	282	106	388
	10	397	71	467	373	77	449	347	85	432	321	95	416	293	107	400
28,2	6	347	71	418	325	76	402	302	84	387	278	96	374	253	113	366
	7	360	71	432	338	77	415	314	85	399	289	97	386	264	113	377
	8	373	72	446	350	78	428	326	86	412	301	97	398	274	114	388
	9	387	73	460	364	78	442	339	86	425	313	98	411	285	114	400
	10	401	73	475	377	79	456	351	87	439	325	99	423	297	115	411
31,1	6	375	74	450	352	81	433	327	90	416	301	100	401	273	113	387
	7	389	75	465	365	82	447	339	90	430	312	101	414	285	114	399
	8	404	76	480	379	83	462	353	91	444	325	102	427	296	115	411
	9	419	76	496	394	83	477	366	92	458	338	103	441	308	116	424
	10	435	77	512	409	84	492	381	93	473	351	104	455	321	117	437
31,2	6	379	76	455	355	82	437	330	91	421	303	102	406	276	118	393
	7	394	76	470	369	83	452	343	92	435	316	103	419	287	119	406
	8	408	77	485	383	84	467	356	92	449	328	104	432	299	119	418
	9	424	78	501	397	84	482	370	93	463	341	105	446	311	120	431
	10	439	78	518	413	85	498	384	94	478	355	106	460	324	121	445
33,2	6	402	81	483	377	89	465	350	98	448	322	110	432	293	124	417
	7	417	82	499	391	89	480	364	99	463	335	110	446	305	125	430
	8	433	83	515	406	90	496	378	100	477	348	111	460	318	126	443
	9	449	83	532	421	91	512	392	100	493	362	112	474	331	127	457
	10	466	84	550	437	92	529	408	101	509	376	113	490	344	128	472
35,2	6	438	87	525	411	95	506	382	105	487	352	118	469	320	133	453
	7	454	88	543	426	96	522	397	106	503	366	119	485	333	134	467
	8	472	89	560	443	97	539	412	107	519	381	120	500	347	135	482
	9	489	90	579	460	98	557	428	108	536	396	121	516	362	136	497
	10	507	90	598	477	98	575	445	109	553	411	122	533	376	137	513
37,2	6	473	93	566	443	101	545	412	112	524	380	125	505	345	145	491
	7	491	94	585	460	102	563	428	113	541	395	127	522	360	146	506
	8	509	95	604	478	103	581	445	114	559	411	128	538	374	147	521
	9	528	96	624	496	104	600	462	115	577	427	129	555	390	147	537
	10	548	96	644	515	105	620	480	116	596	444	130	573	405	148	553

(*) For HT version only

Pf: cooling power [kW]

Pe: electric power absorbed by compressors [kW]

Pr: recovery condenser heat power [kW]

T0: evaporator outlet water temperature [°C] Evaporator thermal gap = 5°C

RECOVERY CAPACITY - KAPPA V EVO /A

Model	To [°C]	OUTPUT WATER TEMPERATURE FROM CONDENSER [°C]														
		35			40			45			50			55 *		
		Pf	Pe	Pr	Pf	Pe	Pr	Pf	Pe	Pr	Pf	Pe	Pr	Pf	Pe	Pr
40,2	6	522	100	622	490	109	599	456	120	577	421	135	556	384	152	536
	7	540	101	641	508	110	617	473	121	595	437	136	573	399	153	552
	8	559	101	660	525	111	636	490	122	612	453	137	590	414	154	568
	9	578	102	680	544	111	655	507	123	630	469	138	607	429	155	584
43,2	6	598	103	701	562	112	675	525	124	649	486	139	625	445	156	601
	7	548	107	655	515	116	631	480	128	608	443	143	586	404	161	565
	8	568	108	676	534	117	651	498	129	627	460	144	604	420	162	582
	9	588	109	696	552	118	671	515	130	646	476	146	622	436	163	599
47,2	6	608	109	717	572	119	691	534	132	665	493	147	640	452	165	616
	7	629	110	739	592	120	712	553	133	685	511	148	659	468	166	634
	8	597	119	717	561	130	691	522	143	665	481	160	641	439	180	619
	7	617	120	738	580	131	711	541	145	685	499	161	660	456	181	637
51,2	8	639	121	760	600	132	732	560	146	706	517	163	680	473	183	656
	9	661	122	783	621	133	754	580	147	727	536	164	700	491	184	675
	6	683	123	806	643	134	777	600	148	748	555	165	721	509	185	694
	7	630	125	756	592	136	728	551	151	701	507	168	676	462	190	652
54,2	8	650	126	776	610	137	747	569	152	720	525	170	695	479	191	671
	9	672	127	799	632	138	770	589	153	742	544	171	715	497	193	690
	6	694	137	831	650	149	799	603	165	768	554	185	739	503	209	711
	7	720	138	859	675	151	826	627	167	794	577	187	763	524	210	735
58,2	8	748	140	887	701	152	853	652	168	820	600	188	788	546	212	759
	9	776	141	917	728	153	881	677	170	847	625	190	814	569	214	783
	6	805	142	947	756	155	910	704	171	875	649	191	841	593	215	808
	7	740	141	881	693	154	846	643	170	813	591	190	781	536	214	750
62,2	8	769	142	911	720	155	875	669	171	840	615	192	807	559	216	775
	9	798	144	942	748	156	905	695	173	868	640	193	833	583	217	800
	6	829	145	973	777	158	935	723	174	897	666	195	861	607	219	826
	7	860	146	1006	806	159	966	751	176	927	692	196	889	632	221	853
66,2	8	820	167	987	766	182	948	709	201	911	650	225	875	589	254	843
	9	849	169	1018	794	184	977	735	203	938	675	227	902	612	255	868
	6	879	170	1049	822	185	1007	762	205	967	700	229	928	635	257	893
	7	910	171	1081	851	187	1037	789	206	995	725	230	955	659	259	918
70,2	8	941	173	1114	880	188	1068	817	208	1024	751	232	983	683	261	944
	6	878	164	1042	822	179	1001	763	198	960	700	221	921	635	249	884
	7	912	166	1078	854	180	1035	793	199	993	729	223	952	663	251	914
	8	947	167	1114	887	182	1069	824	201	1025	759	225	984	691	253	944
74,2	9	982	168	1151	921	183	1104	856	203	1059	788	227	1015	718	255	973
	6	1018	170	1188	955	185	1140	888	204	1092	818	228	1047	746	257	1003
	7	943	188	1131	883	205	1087	819	226	1045	752	253	1005	682	285	967
	8	980	190	1169	918	207	1124	851	228	1080	782	255	1037	710	287	998
78,2	9	1016	191	1208	951	208	1160	883	230	1113	812	257	1069	738	289	1027
	6	1053	193	1245	985	210	1195	915	232	1147	842	259	1101	766	292	1058
	7	1089	194	1284	1020	212	1232	948	234	1181	872	261	1133	795	294	1088
	8	961	188	1149	902	203	1106	839	224	1063	772	250	1022	701	282	982
82,2	9	996	190	1185	935	206	1141	871	227	1097	801	253	1054	728	285	1013
	6	1031	192	1223	969	209	1177	902	230	1132	831	257	1087	756	289	1045
	7	1067	194	1261	1003	211	1214	934	233	1167	861	260	1121	784	293	1076
	8	1104	197	1301	1038	214	1252	967	236	1203	892	263	1155	812	296	1109
86,2	6	1021	196	1218	958	213	1171	891	235	1126	819	262	1081	743	295	1038
	7	1058	199	1257	993	216	1209	924	238	1162	849	265	1115	771	299	1070
	8	1095	201	1296	1028	218	1247	956	241	1197	880	269	1148	799	303	1102
	9	1133	203	1336	1063	221	1284	989	244	1233	910	272	1182	827	307	1134
88,2	6	1170	206	1376	1098	224	1322	1022	247	1269	941	276	1217	856	310	1166

(*) For HT version only

Pf: cooling power [kW]

Pe: electric power absorbed by compressors [kW]

Pr: recovery condenser heat power [kW]

T0: evaporator outlet water temperature [°C] Evaporator thermal gap = 5°C

RECOVERY CAPACITY - KAPPA V EVO /A

Model	To	OUTPUT WATER TEMPERATURE FROM CONDENSER [°C]														
	[°C]	35			40			45			50			55 *		
		Pf	Pe	Pr	Pf	Pe	Pr	Pf	Pe	Pr	Pf	Pe	Pr	Pf	Pe	Pr
90,2	6	1101	214	1315	1032	232	1264	959	256	1214	880	286	1165	797	322	1119
	7	1140	216	1356	1068	235	1303	992	259	1250	910	289	1199	825	326	1151
	8	1178	219	1397	1103	238	1341	1025	262	1287	941	293	1234	853	330	1183
	9	1216	221	1437	1139	241	1380	1058	265	1323	972	296	1268	882	334	1216
	10	1255	224	1478	1175	244	1419	1092	269	1361	1004	300	1303	911	338	1249
95,2	6	1163	229	1392	1089	249	1338	1009	274	1283	925	306	1232	837	345	1183
	7	1202	232	1434	1126	251	1377	1043	278	1320	957	310	1267	866	349	1216
	8	1241	234	1476	1162	254	1417	1077	281	1358	988	314	1302	896	354	1249
	9	1281	237	1518	1200	257	1457	1112	285	1396	1021	318	1338	926	358	1284
	10	1322	239	1561	1238	260	1498	1147	288	1435	1054	322	1375	956	362	1318
100,2	6	1250	251	1501	1174	271	1446	1096	298	1393	1007	333	1340	916	375	1291
	7	1296	253	1550	1218	274	1493	1137	301	1438	1046	337	1383	953	379	1332
	8	1344	256	1600	1262	277	1539	1180	304	1484	1086	340	1427	991	383	1373
	9	1390	259	1649	1308	280	1588	1221	308	1529	1127	344	1471	1029	387	1416
	10	1440	261	1701	1355	283	1638	1265	312	1576	1169	347	1516	1068	391	1459
105,2	6	1314	258	1571	1239	278	1517	1157	306	1464	1071	341	1412	976	386	1362
	7	1356	260	1616	1279	281	1560	1196	309	1505	1107	345	1452	1009	390	1399
	8	1403	262	1665	1323	284	1607	1238	312	1550	1144	349	1493	1047	393	1440
	9	1450	265	1715	1368	287	1654	1278	316	1595	1184	353	1537	1085	397	1482
	10	1495	268	1763	1411	290	1701	1324	319	1642	1226	356	1582	1124	401	1525
115,2	6	1462	284	1746	1377	308	1685	1287	339	1625	1189	378	1567	1086	425	1512
	7	1508	287	1795	1421	311	1732	1328	342	1671	1229	382	1610	1123	430	1553
	8	1558	290	1848	1469	314	1783	1374	346	1720	1271	386	1657	1163	435	1598
	9	1609	293	1902	1518	318	1835	1420	350	1770	1315	390	1705	1204	439	1643
	10	1661	296	1957	1567	321	1888	1467	354	1820	1359	395	1754	1245	444	1689
120,2	6	1525	333	1858	1464	370	1833	1395	411	1806	1322	457	1779	1243	508	1751
	7	1570	335	1905	1504	374	1878	1436	414	1850	1362	459	1821	1281	511	1792
	8	1616	339	1955	1551	376	1927	1482	416	1898	1405	462	1867	1322	514	1836
	9	1665	342	2007	1598	379	1977	1527	419	1946	1448	465	1914	1364	517	1881
	10	1716	344	2060	1647	382	2028	1574	422	1996	1493	468	1961	1406	520	1926
130,2	6	1561	305	1866	1501	338	1838	1433	375	1808	1358	417	1776	1279	464	1743
	7	1607	307	1914	1543	341	1884	1474	378	1852	1398	420	1818	1317	467	1784
	8	1657	309	1966	1590	344	1934	1520	381	1900	1442	423	1865	1359	469	1828
	9	1707	311	2018	1639	346	1985	1566	383	1950	1487	425	1912	1402	472	1874
	10	1756	315	2071	1688	349	2037	1614	386	2000	1532	428	1960	1445	475	1920
140,2	6	1603	323	1926	1543	358	1900	1475	396	1872	1399	442	1841	1320	491	1811
	7	1651	325	1975	1588	360	1948	1516	400	1916	1440	444	1884	1358	494	1852
	8	1702	327	2029	1635	364	1998	1563	403	1966	1485	447	1932	1401	496	1898
	9	1754	329	2083	1684	366	2051	1611	406	2017	1531	450	1981	1445	499	1944
	10	1804	333	2137	1735	369	2104	1660	409	2068	1577	453	2030	1489	502	1991

(*) For HT version only

Pf: cooling power [kW]

Pe: electric power absorbed by compressors [kW]

Pr: recovery condenser heat power [kW]

TO: evaporator outlet water temperature [°C] Evaporator thermal gap = 5°C

SOUND LEVEL - KAPPA V EVO - STANDARD UNIT

MODELLO	Octave bande [dB]																Total [dB(A)]	
	63 Hz		125 Hz		250 Hz		500 Hz		1000 Hz		2000 Hz		4000 Hz		8000 Hz		Lw	Lp
	Lw	Lp	Lw	Lp	Lw	Lp	Lw	Lp	Lw	Lp	Lw	Lp	Lw	Lp	Lw	Lp		
23.1	77	45	76	44	81	49	81	49	89	57	88	56	83	51	75	43	93	61
25.1	78	46	76	44	81	49	81	49	89	57	87	55	83	51	75	43	93	61
28.1	78	46	76	44	81	49	80	48	90	58	87	55	83	51	74	42	93	61
31.1	79	47	77	45	82	50	81	49	91	59	88	56	83	51	75	43	94	62
33.2	78	46	77	45	82	50	82	50	90	58	89	57	85	53	77	45	94	62
35.2	79	47	78	46	83	51	83	51	91	59	90	58	85	53	78	46	95	63
37.2	79	47	78	46	83	51	83	51	91	59	90	58	85	53	78	46	95	63
40.2	80	48	79	47	84	52	84	52	92	60	91	59	86	54	78	46	96	64
43.2	80	48	79	47	84	52	84	52	92	60	91	59	86	54	79	47	96	64
47.2	81	49	80	48	85	53	85	53	93	61	92	60	87	55	79	47	97	65
51.2	81	49	80	48	85	53	85	53	93	61	91	59	87	55	78	46	97	65
54.2	83	51	81	49	86	54	85	53	95	63	92	60	87	55	79	47	98	66
58.2	82	49	81	48	86	53	85	52	95	62	93	60	88	55	79	46	98	65
61.2	83	50	82	49	87	54	86	53	96	63	94	61	89	56	80	47	99	66
67.2	83	50	82	49	87	54	86	53	96	63	93	60	89	56	80	47	99	66
70.2	83	50	82	49	87	54	86	53	96	63	93	60	88	55	80	47	99	66
73.2	84	51	83	50	88	55	87	54	97	64	94	61	89	56	80	47	100	67
80.2	84	51	83	50	88	55	87	54	97	64	94	61	89	56	80	47	100	67
82.2	84	51	83	50	88	55	87	54	97	64	94	61	89	56	80	47	100	67
85.2	84	51	83	50	88	55	87	54	97	64	94	61	89	56	81	48	100	67
90.2	84	51	83	50	88	55	87	54	97	64	94	61	89	56	81	48	100	67
95.2	85	52	83	50	89	56	88	55	98	65	95	62	90	57	81	48	101	68
100.2	85	52	83	50	89	56	88	55	98	65	95	62	90	57	81	48	101	68
105.2	86	53	84	51	90	57	89	56	99	66	96	63	91	58	82	49	102	69
110.2	86	53	84	51	90	57	89	56	99	66	96	63	91	58	82	49	102	69
115.2	86	53	84	51	90	57	89	56	99	66	96	63	91	58	82	49	102	69
120.2	86	53	84	51	90	57	89	56	99	66	96	63	91	58	82	49	102	69
130.2	87	54	85	52	91	58	90	57	100	67	97	64	92	59	83	50	103	70
140.2	87	54	85	52	91	58	90	57	100	67	97	64	92	59	82	49	103	70
150.4	87	54	86	53	91	58	90	57	100	67	97	64	92	59	83	50	103	70
160.4	87	54	86	53	91	58	90	57	100	67	97	64	92	59	83	50	103	70
180.4	88	55	87	54	92	59	91	58	101	68	98	65	93	60	84	51	104	71

Lw:sound power values in free field calculated in compliance with ISO 3744.

Lp: sound pressure levels refer to 10 meters from unit in free field at nominal working conditions, compliant to ISO 3744.

SOUND LEVEL - KAPPA V EVO - LOW NOISE UNIT

MODEL	Octave bande [dB]																Total [dB(A)]	
	63 Hz		125 Hz		250 Hz		500 Hz		1000 Hz		2000 Hz		4000 Hz		8000 Hz		Lw	Lp
	Lw	Lp	Lw	Lp	Lw	Lp	Lw	Lp	Lw	Lp	Lw	Lp	Lw	Lp	Lw	Lp		
23.1	72	40	71	39	76	44	75	43	83	51	81	49	77	45	70	38	87	55
25.1	72	40	71	39	76	44	75	43	83	51	81	49	77	45	70	38	87	55
28.1	73	41	71	39	76	44	75	43	83	51	81	49	77	45	69	37	87	55
31.1	74	42	72	40	77	45	76	44	84	52	82	50	78	46	70	38	88	56
33.2	74	42	73	41	77	45	78	46	85	53	84	52	80	48	73	41	89	57
35.2	74	42	73	41	77	45	78	46	85	53	84	52	80	48	73	41	89	57
37.2	74	42	73	41	77	45	78	46	85	53	84	52	80	48	73	41	89	57
40.2	75	43	74	42	78	46	78	46	86	54	84	52	80	48	73	41	90	58
43.2	75	43	74	42	78	46	79	47	86	54	84	52	80	48	74	42	90	58
47.2	76	44	75	43	80	48	79	47	87	55	85	53	81	49	74	42	91	59
51.2	76	44	75	43	80	48	79	47	87	55	85	53	81	49	74	42	91	59
54.2	77	45	76	44	81	49	80	48	88	56	86	54	82	50	74	42	92	60
58.2	77	44	76	43	80	47	80	47	88	55	86	53	82	49	74	41	92	59
61.2	77	44	76	43	80	47	80	47	88	55	86	53	82	49	75	42	92	59
67.2	78	45	77	44	81	48	81	48	89	56	87	54	83	50	75	42	93	60
70.2	78	45	77	44	81	48	81	48	89	56	87	54	83	50	75	42	93	60
73.2	79	46	78	45	82	49	82	49	90	57	88	55	84	51	76	43	94	61
80.2	79	46	78	45	82	49	82	49	90	57	88	55	84	51	75	42	94	61
82.2	79	46	78	45	82	49	82	49	90	57	88	55	84	51	75	42	94	61
85.2	79	46	78	45	82	49	82	49	90	57	88	55	84	51	76	43	94	61
90.2	80	47	78	45	83	50	83	50	91	58	89	56	85	52	77	44	95	62
95.2	80	47	78	45	83	50	83	50	91	58	89	56	85	52	77	44	95	62
100.2	80	47	78	45	83	50	83	50	91	58	89	56	85	52	76	43	95	62
105.2	81	48	79	46	84	51	83	50	93	60	90	57	86	53	77	44	96	63
110.2	81	48	79	46	84	51	83	50	93	60	90	57	86	53	77	44	96	63
115.2	81	48	79	46	84	51	83	50	93	60	90	57	86	53	77	44	96	63
120.2	82	49	80	47	85	52	84	51	94	61	91	58	87	54	78	45	97	64
130.2	82	49	80	47	85	52	84	51	94	61	91	58	86	53	78	45	97	64
140.2	82	49	80	47	85	52	84	51	94	61	91	58	86	53	77	44	97	64
150.4	82	49	81	48	85	52	85	52	93	60	91	58	87	54	78	45	97	64
160.4	82	49	81	48	85	52	85	52	93	60	91	58	87	54	78	45	97	64
180.4	83	50	81	48	86	53	85	52	95	62	92	59	88	55	79	46	98	65

Lw:sound power values in free field calculated in compliance with ISO 3744.

Lp: sound pressure levels refer to 10 meters from unit in free field at nominal working conditions, compliant to ISO 3744.

SOUND LEVEL - KAPPA V EVO - SUPER LOW NOISE UNIT

MODEL	Octave bande [dB]																Total [dB(A)]	
	63 Hz		125 Hz		250 Hz		500 Hz		1000 Hz		2000 Hz		4000 Hz		8000 Hz		Lw	Lp
	Lw	Lp	Lw	Lp	Lw	Lp	Lw	Lp	Lw	Lp	Lw	Lp	Lw	Lp	Lw	Lp		
23.1	68	36	67	35	71	39	71	39	78	46	76	44	73	41	66	34	82	50
25.1	68	36	67	35	71	39	71	39	78	46	76	44	72	40	66	34	82	50
28.1	69	37	68	36	72	40	71	39	79	47	77	45	73	41	66	34	83	51
31.1	69	37	68	36	72	40	71	39	79	47	77	45	73	41	66	34	83	51
33.2	69	37	68	36	72	40	72	40	78	46	77	45	74	42	68	36	83	51
35.2	70	38	69	37	73	41	73	41	79	47	78	46	75	43	69	37	84	52
37.2	70	38	69	37	73	41	73	41	79	47	78	46	75	43	69	37	84	52
40.2	71	39	70	38	74	42	74	42	81	49	79	47	76	44	69	37	85	53
43.2	71	39	70	38	74	42	74	42	81	49	79	47	76	44	69	37	85	53
47.2	71	39	70	38	74	42	74	42	81	49	79	47	75	43	69	37	85	53
51.2	71	39	70	38	74	42	74	42	81	49	79	47	75	43	69	37	85	53
54.2	72	40	71	39	75	43	74	42	82	50	80	48	76	44	69	37	86	54
58.2	72	39	71	38	75	42	75	42	82	49	80	47	76	43	70	37	86	53
61.2	72	39	71	38	75	42	75	42	82	49	80	47	76	43	70	37	86	53
67.2	73	40	72	39	76	43	75	42	83	50	81	48	77	44	70	37	87	54
70.2	73	40	72	39	76	43	75	42	83	50	81	48	77	44	70	37	87	54
73.2	74	41	73	40	77	44	76	43	84	51	82	49	78	45	71	38	88	55
80.2	74	41	73	40	77	44	76	43	84	51	82	49	78	45	71	38	88	55
82.2	74	41	73	40	77	44	76	43	84	51	82	49	78	45	71	38	88	55
85.2	75	42	73	40	78	45	77	44	85	52	83	50	79	46	72	39	89	56
90.2	76	43	74	41	79	46	78	45	86	53	84	51	80	47	73	40	90	57
95.2	76	43	74	41	79	46	78	45	86	53	84	51	80	47	73	40	90	57
100.2	76	43	74	41	79	46	78	45	86	53	84	51	80	47	72	39	90	57
105.2	77	44	75	42	80	47	79	46	87	54	85	52	81	48	73	40	91	58
110.2	77	44	75	42	80	47	79	46	87	54	85	52	81	48	73	40	91	58
115.2	77	44	75	42	80	47	79	46	87	54	85	52	81	48	73	40	91	58
120.2	77	44	76	43	81	48	80	47	88	55	86	53	82	49	74	41	92	59
130.2	78	45	76	43	81	48	80	47	88	55	86	53	82	49	74	41	92	59
140.2	78	45	76	43	81	48	80	47	88	55	86	53	82	49	74	41	92	59
150.4	78	45	76	43	81	48	80	47	88	55	86	53	82	49	74	41	92	59
160.4	78	45	76	43	81	48	80	47	88	55	86	53	82	49	74	41	92	59
180.4	79	46	77	44	82	49	81	48	89	56	87	54	83	50	75	42	93	60

Lw:sound power values in free field calculated in compliance with ISO 3744.

Lp: sound pressure levels refer to 10 meters from unit in free field at nominal working conditions, compliant to ISO 3744.

SOUND LEVEL - KAPPA V EVO /A- STANDARD UNIT

MODEL	Octave bande [dB]																Total [dB(A)]	
	63 Hz		125 Hz		250 Hz		500 Hz		1000 Hz		2000 Hz		4000 Hz		8000 Hz		Lw	Lp
	Lw	Lp	Lw	Lp	Lw	Lp	Lw	Lp	Lw	Lp	Lw	Lp	Lw	Lp	Lw	Lp		
23.1	76	44	76	44	80	48	81	49	88	56	88	56	82	50	75	43	92	60
23.2	75	43	76	43	81	49	81	49	87	55	88	56	82	50	74	42	92	60
25.1	77	45	76	44	80	48	81	49	88	56	87	55	82	50	75	43	92	60
25.2	76	44	76	43	81	49	81	49	88	56	88	56	83	51	74	42	92	60
28.1	78	46	76	44	81	49	81	49	90	58	88	56	84	52	75	43	93	61
28.2	78	46	76	44	81	49	80	48	90	58	87	55	83	51	74	42	93	61
31.1	78	46	77	45	82	50	81	49	90	58	88	56	84	52	76	44	94	62
31.2	77	45	78	46	82	50	81	49	91	59	89	57	84	52	76	44	94	62
33.2	78	46	77	45	82	50	82	50	90	58	89	57	84	52	77	45	94	62
35.2	79	47	78	46	83	51	84	52	91	59	90	58	85	53	79	47	95	63
37.2	80	48	78	46	84	52	83	51	92	60	91	59	85	53	79	47	96	64
40.2	80	48	79	47	84	52	84	52	92	60	91	59	86	54	78	46	96	64
43.2	79	47	79	47	84	52	84	52	92	60	91	59	86	54	79	46	96	64
47.2	82	50	81	49	85	53	85	53	94	62	93	61	87	55	79	47	98	66
51.2	82	50	81	49	85	53	85	53	94	62	92	60	87	55	79	47	97	65
54.2	83	51	81	49	86	54	85	53	95	63	93	61	88	56	79	47	98	66
61.2	83	50	82	49	87	54	86	53	96	63	94	61	89	56	80	47	99	66
70.2	83	51	83	51	87	55	86	54	97	65	94	62	89	57	80	48	100	68
73.2	84	52	83	51	88	56	86	54	96	64	94	62	90	58	80	48	100	68
80.2	84	52	83	51	89	57	87	55	97	65	95	63	89	57	80	48	100	68
82.2	83	50	83	50	88	55	87	54	97	64	94	61	89	56	80	47	100	67
85.2	84	51	83	50	88	55	87	54	97	64	94	61	89	56	81	48	100	67
90.2	85	53	83	51	89	57	88	56	98	66	95	63	90	58	82	50	101	69
95.2	85	53	84	52	89	57	88	56	98	66	95	63	91	59	81	49	101	69
100.2	86	54	84	52	89	57	88	56	98	66	96	64	90	58	81	49	101	69
105.2	86	54	84	52	90	58	89	57	99	67	96	64	91	59	82	50	102	70
115.2	87	55	84	52	91	59	89	57	100	68	96	64	92	60	82	50	103	71
120.2	87	55	85	53	91	59	89	57	100	68	96	64	92	60	82	50	103	71
130.2	87	55	86	54	91	59	90	58	101	69	97	65	92	60	83	51	104	72
140.2	87	55	86	54	92	60	90	58	101	69	97	65	93	61	82	50	104	72
150.4	88	56	86	54	92	60	90	58	101	69	97	65	93	61	83	51	104	72

Lw:sound power values in free field calculated in compliance with ISO 3744.

Lp: sound pressure levels refer to 10 meters from unit in free field at nominal working conditions, compliant to ISO 3744.

SOUND LEVEL - KAPPA V EVO /A- LOW NOISE UNIT

MODEL	Octave bande [dB]																Total [dB(A)]	
	63 Hz		125 Hz		250 Hz		500 Hz		1000 Hz		2000 Hz		4000 Hz		8000 Hz		Lw	Lp
	Lw	Lp	Lw	Lp	Lw	Lp	Lw	Lp	Lw	Lp	Lw	Lp	Lw	Lp	Lw	Lp		
23.1	72	40	70	38	74	42	75	43	83	51	81	49	77	45	70	38	87	55
23.2	71	39	71	39	75	43	75	42	82	50	81	49	77	45	69	37	86	54
25.1	72	40	71	39	76	44	77	45	83	51	81	49	77	45	70	38	87	55
25.2	72	40	71	39	75	43	75	43	82	50	81	49	77	45	70	38	87	55
28.1	72	40	71	39	75	43	76	44	83	51	81	49	77	45	69	37	87	55
28.2	73	41	72	40	76	44	76	44	83	51	82	50	77	45	70	38	87	55
31.1	74	42	72	40	77	45	75	43	84	52	82	50	78	46	70	38	88	56
31.2	73	41	73	41	77	45	77	45	85	53	73	41	80	48	72	40	88	56
33.2	74	42	73	41	77	45	78	46	85	53	84	52	80	48	73	41	89	57
35.2	75	43	74	42	78	46	78	46	85	53	84	52	80	48	73	41	89	57
37.2	74	42	73	41	77	45	78	46	85	53	84	52	80	48	73	41	89	57
40.2	74	42	74	42	78	46	78	46	86	54	84	52	80	48	73	41	90	58
43.2	76	44	74	42	79	47	79	47	86	54	84	52	80	48	74	42	90	58
47.2	77	45	75	43	80	48	79	47	87	55	85	53	81	49	74	42	91	59
51.2	76	44	75	43	80	48	80	48	87	55	85	53	81	49	74	42	91	59
54.2	77	45	76	44	81	49	80	48	88	56	86	54	82	50	74	42	92	60
61.2	77	45	76	44	82	50	81	49	88	56	86	54	82	50	75	42	92	60
70.2	78	46	77	45	81	49	81	49	89	57	87	55	83	51	75	42	93	61
73.2	79	47	79	47	82	50	82	50	90	58	88	56	84	52	76	43	94	62
80.2	78	46	78	46	82	50	82	50	90	58	88	56	84	52	75	42	94	62
82.2	79	47	78	46	82	50	82	50	90	58	88	56	84	52	75	42	94	62
85.2	80	48	79	47	84	52	82	50	90	58	88	56	84	52	76	43	94	62
90.2	80	48	78	46	83	51	83	51	91	59	89	57	85	53	77	44	95	63
95.2	81	49	78	46	83	51	83	51	91	59	89	57	85	53	77	44	95	63
100.2	80	48	78	46	83	51	83	51	91	59	89	57	85	53	76	43	95	63
105.2	82	50	80	48	85	53	84	52	93	61	90	58	86	54	77	44	96	64
115.2	82	50	81	49	86	54	84	52	93	61	90	58	86	54	77	44	96	64
120.2	82	50	80	48	86	54	84	52	94	62	91	59	87	55	78	45	97	65
130.2	82	50	81	49	86	54	85	53	94	62	91	59	86	54	78	45	97	65
140.2	83	51	81	49	87	55	85	53	94	62	91	59	86	54	77	44	97	65
150.4	82	50	81	49	85	53	85	53	93	61	91	59	87	55	78	45	97	65

Lw:sound power values in free field calculated in compliance with ISO 3744.

Lp: sound pressure levels refer to 10 meters from unit in free field at nominal working conditions, compliant to ISO 3744.

SOUND LEVEL - KAPPA V EVO /A- SUPER LOW NOISE UNIT

MODEL	Octave bande [dB]																Total [dB(A)]	
	63 Hz		125 Hz		250 Hz		500 Hz		1000 Hz		2000 Hz		4000 Hz		8000 Hz		Lw	Lp
	Lw	Lp	Lw	Lp	Lw	Lp	Lw	Lp	Lw	Lp	Lw	Lp	Lw	Lp	Lw	Lp		
23.1	67	35	67	35	70	38	71	39	77	45	76	44	72	40	66	34	82	50
23,2	68	36	66	34	71	39	70	38	78	46	75	43	73	41	66	34	82	50
25.1	67	35	67	35	71	39	70	38	78	46	76	44	72	40	65	33	82	50
25,2	68	36	67	35	70	38	71	39	77	45	76	44	72	40	66	34	82	50
28.1	69	37	68	36	72	40	71	39	79	47	77	45	73	41	66	34	83	51
28,2	68	36	68	36	71	39	71	39	78	46	77	45	72	40	66	34	82	50
31.1	69	37	68	36	72	40	71	39	79	47	77	45	73	41	66	34	83	51
31,2	68	36	68	36	72	40	71	39	79	47	76	44	73	41	66	34	83	51
33.2	69	37	68	36	72	40	72	40	78	46	77	45	74	42	68	36	83	51
35.2	70	38	69	37	72	40	73	41	78	46	78	46	75	43	69	37	83	51
37.2	70	38	69	37	73	41	73	41	79	47	78	46	75	43	69	37	84	52
40.2	71	39	69	37	74	42	73	41	81	49	79	47	76	44	68	36	85	53
43.2	71	39	70	38	74	42	74	42	81	49	79	47	76	44	69	37	85	53
47.2	71	39	70	38	74	42	74	42	82	50	79	47	75	43	70	38	86	54
51.2	71	39	70	38	74	42	74	42	81	49	79	47	75	43	69	37	85	53
54.2	71	39	71	39	75	43	74	42	81	49	80	48	76	44	69	37	86	54
61.2	72	40	71	39	75	43	75	43	82	50	80	48	76	44	70	38	86	54
70.2	73	41	72	40	76	44	75	43	83	51	81	49	77	45	70	38	87	55
73,2	73	41	73	41	76	44	76	44	84	52	81	49	78	46	71	39	88	56
80.2	74	42	73	41	77	45	76	44	84	52	82	50	78	46	71	39	88	56
85.2	75	43	73	41	78	46	77	45	85	53	83	51	79	47	72	40	89	57
90.2	75	43	74	42	79	47	77	45	86	54	84	52	80	48	73	41	90	58
95.2	76	44	74	42	79	47	78	46	86	54	84	52	80	48	73	41	90	58
100,2	76	44	74	42	79	47	78	46	86	54	84	52	80	48	72	40	90	58
105.2	76	44	75	43	79	47	79	47	87	55	84	52	81	49	73	41	91	59
115.2	77	45	75	43	80	48	79	47	87	55	85	53	81	49	73	41	91	59
120.2	77	45	76	44	81	49	80	48	88	56	86	54	82	50	74	42	92	60
130.2	77	45	76	44	80	48	80	48	88	56	86	54	81	49	74	42	92	60
140.2	78	46	76	44	81	49	80	48	88	55	86	54	81	49	74	42	92	59

Lw:sound power values in free field calculated in compliance with ISO 3744.

Lp: sound pressure levels refer to 10 meters from unit in free field at nominal working conditions, compliant to ISO 3744.

DIMENSIONAL DATA

KAPPA V EVO 23.1-31.1

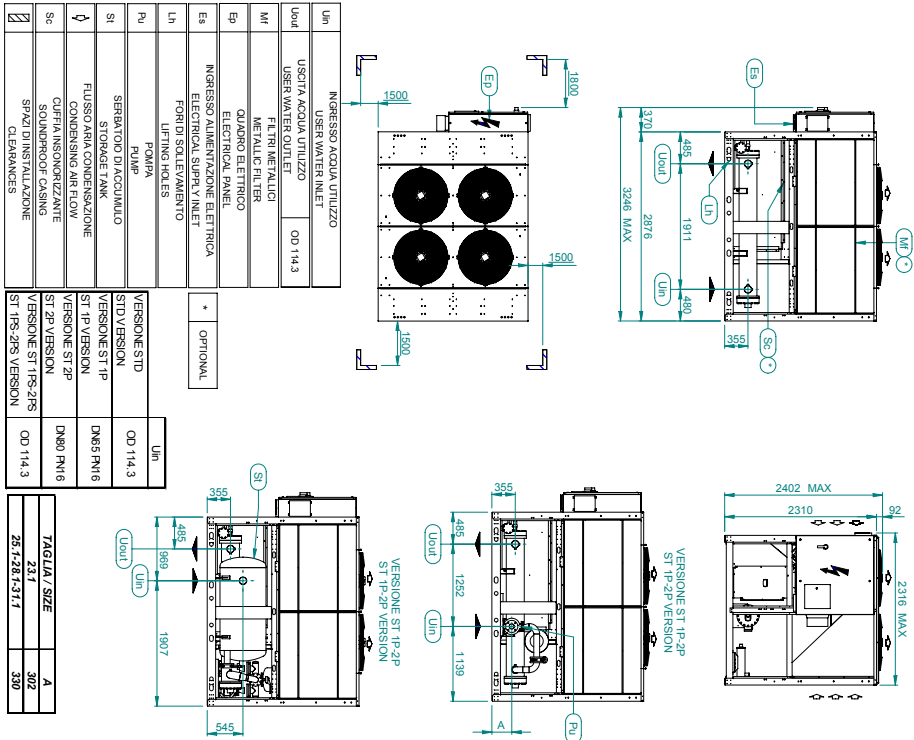

Uin	INGRESSO ACQUA UTILIZZO USER WATER INLET		
Uout	USCITA ACQUA UTILIZZO USER WATER OUTLET	OD 114.3	
Mf	FILTRI METALLICI METALLIC FILTER		
Ep	QUADRO ELETTRICO ELECTRICAL PANEL		
Es	INGRESSO ALIMENTAZIONE ELETTRICA ELECTRICAL SUPPLY INLET		OPTIONAL
Lh	FORI DI SOLLIEVAMENTO LIFTING HOLES		
Pu	PUNTA PUMP		Uin
Si	SERBATOIO DI ACCUMULO STORAGE TANK		OD 114.3
Fl	FLUSSO STAMPATO COMPARISON BOARD		DM69 PM6
Sc	OUTER INSULATION SOUNDPROOF CASING		DM80 PM6
Cl	SPAZI DI INSTALLAZIONE CLEARANCES		OD 114.3

VERSIONE STD	Uin
ST-D VERSION	OD 114.3
VERSIONE ST-IP	DM69 PM6
ST-IP VERSION	DM80 PM6
VERSIONE ST-2P	
ST-2P VERSION	
VERSIONE ST-IPS-2PS	
ST-IPS-2PS VERSION	

TAGLIA / SIZE		A
23.1		302
25.1-28.1-31.1		330

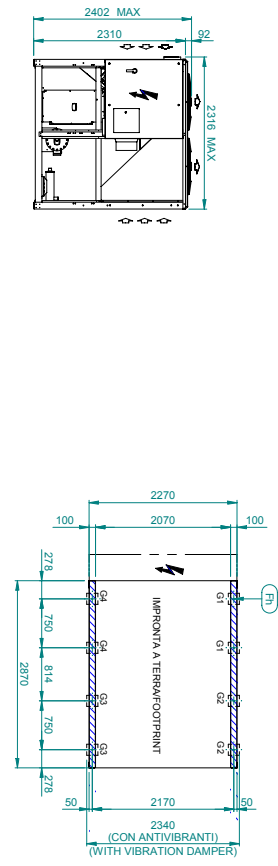

MODELLO	PESO (KG) WEIGHT (KG)	PESO IN FUNZIONE (KG) OPERATING WEIGHT (KG)	G1 (KG)	G2 (KG)	G3 (KG)	G4 (KG)
KAPPA V.EVO LN 23.1	2315	2440	433	283	188	326
KAPPA V.EVO LN 23.1	2315	2440	443	300	235	347
KAPPA V.EVO ST-IP-2P 23.1	2488	2632	433	284	237	382
KAPPA V.EVO ST-IP-2P LN 23.1	2710	2844	444	321	278	391
KAPPA V.EVO ST-IPS-2PS LN 23.1	2617	2666	472	378	388	480
KAPPA V.EVO LN 25.1	2385	2527	462	270	199	334
KAPPA V.EVO LN 25.1	2385	2527	461	307	236	355
KAPPA V.EVO LN 25.1	2593	2718	483	296	248	379
KAPPA V.EVO ST-IP-2P 25.1	2618	2792	486	333	287	399
KAPPA V.EVO ST-IP-2P LN 25.1	2832	2966	484	328	287	399
KAPPA V.EVO ST-IPS-2PS LN 25.1	2745	2942	492	406	381	482
KAPPA V.EVO LN 28.1	2450	2590	504	441	420	480
KAPPA V.EVO LN 28.1	2450	2590	454	280	212	344
KAPPA V.EVO LN 28.1	2593	2728	484	317	249	394
KAPPA V.EVO ST-IP-2P 28.1	2697	2838	456	306	262	388
KAPPA V.EVO ST-IP-2P LN 28.1	2899	3038	467	343	300	409
KAPPA V.EVO ST-IPS-2PS 28.1	2808	2952	496	415	394	471
KAPPA V.EVO ST-IPS-2PS LN 28.1	3018	3162	508	450	434	489
KAPPA V.EVO LN 31.1	2512	2642	471	286	213	351
KAPPA V.EVO LN 31.1	2718	2848	480	323	250	371
KAPPA V.EVO ST-IP-2P 31.1	2745	2894	472	312	282	386
KAPPA V.EVO ST-IP-2P LN 31.1	2959	3098	483	348	301	416
KAPPA V.EVO ST-IPS-2PS 31.1	2870	3014	511	422	359	479
KAPPA V.EVO ST-IPS-2PS LN 31.1	3078	3222	523	457	434	497

F1	FORI DI FISSAGGIO FIXING HOLES	Ø18
G.	PUNTI DI APPESO ANTI-VIBRANTI VIBRATION DAMPERS POINTS	

A4B498B

KAPPA V EVO 33.2-40.2

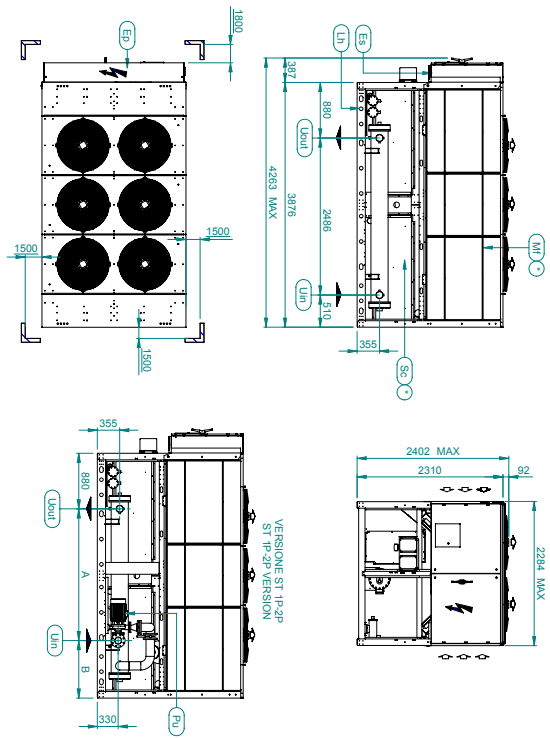

Uin	INGRESSO ACQUA UTILIZZO USER WATER INLET	VERSIONE STD STD VERSION	Uin	A	B
Uout	USCITA ACQUA UTILIZZO USER WATER OUTLET	VERSIONE ST1P ST1P VERSION	Uin	✓	✓
Uin	FORI DI SOGLIAMENTO LIFTING HOLES	VERSIONE ST2P ST2P VERSION	Uin100 Pn16	2086	910
M	FILTRI METALLICI METALLIC FILTER	VERSIONE ST1P2P ST1P2P VERSION	Pu	PU	POMPA PUMP
Ep	QUADRO ELETTRICO ELECTRICAL PANEL	VERSIONE ST1P2P ST1P2P VERSION	Pu	✓	FLUSSO ARIA CONDENSAZIONE CONDENSING AIR FLOW
Es	INGRESSO ALIMENTAZIONE ELETTRICA ELECTRICAL SUPPLY INLET	VERSIONE ST1P2P40.2 ST1P2P40.2 VERSION	Sc	Sc	COPPIA RISONNANZE SOUND/NOISE CASINGS
				✓	SPAZI DI INSTALLAZIONE CLEARANCES
				○	* OPTIONAL

Fi	FORI DI FISSAGGIO FIXING HOLES	Ø18
G	PIANTILI PERGOLE ANTIVIBRANTI VIBRATION DAMPER FOOT HOLDS	

MODELLO	PESO (KG) WEIGHT(KG)	PESO IN FUNZIONE (KG) OPERATING WEIGHT(KG)	G1 (KG)	G2(KG)	G3(KG)	G4 (KG)
KAPPA V EVO 33.2	3345	3488	552	400	326	391
KAPPA V EVO LN33.2	3783	3906	640	548	353	415
KAPPA V EVO ST1P2P33.2	3985	3988	640	598	385	427
KAPPA V EVO ST1P2PLN33.2	4013	4136	629	580	412	447
KAPPA V EVO 33.2	3303	3416	594	353	323	358
KAPPA V EVO LN33.2	3753	3895	632	537	351	413
KAPPA V EVO ST1P2P33.2	3956	3946	632	597	382	419
KAPPA V EVO ST1P2PLN33.2	4078	4276	628	572	405	444
KAPPA V EVO LN37.2	3813	3926	626	546	354	416
KAPPA V EVO ST1P2P37.2	3983	3706	639	584	413	448
KAPPA V EVO ST1P2PLN37.2	4033	4156	639	594	413	448
KAPPA V EVO LN40.2	3396	3506	561	409	329	394
KAPPA V EVO ST1P2P40.2	3846	3956	649	554	357	418
KAPPA V EVO ST1P2PLN40.2	3814	3724	561	503	388	425
KAPPA V EVO ST1P2PLN40.2	4084	4194	638	589	415	450

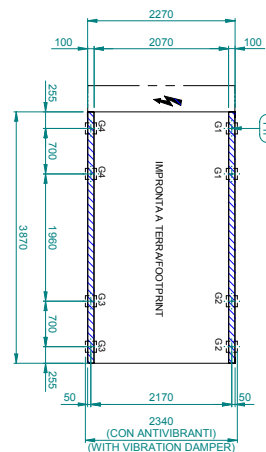

A4B174C

KAPPA V EVO 43.2-58.2

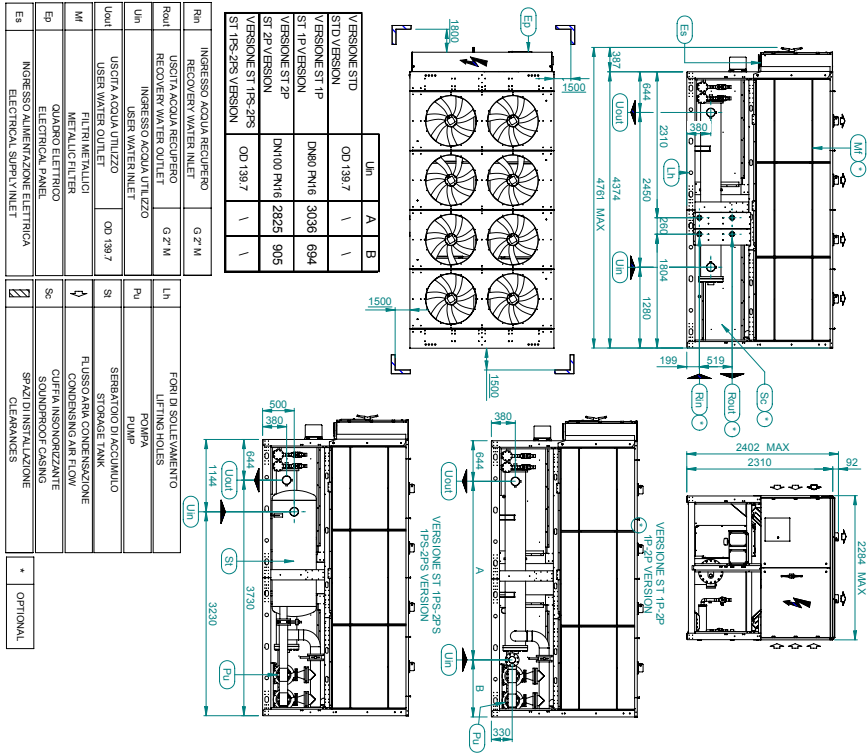

MODELLO	PESORINO (KG)	PESORINO OPERATIVO (KG)	G. (KG)	G. (KG)	G. (KG)
KAPPA V EVO 43.2	3800	3800	988	444	327
KAPPA V EVO ST-1P 43.2	3800	3800	988	444	327
KAPPA V EVO ST-2P 43.2	3804	3804	1000	500	350
KAPPA V EVO ST-1HS-2PS 43.2	4004	4004	1000	500	350
KAPPA V EVO ST-1P 43.2	4108	4108	995	539	351
KAPPA V EVO ST-2P 43.2	4004	4004	995	485	348
KAPPA V EVO ST-1HS-2PS 43.2	4138	4138	1000	500	350
KAPPA V EVO 47.2	4778	4778	1144	572	414
KAPPA V EVO ST-1P 47.2	4778	4778	1144	572	414
KAPPA V EVO ST-2P 47.2	4782	4782	1150	575	415
KAPPA V EVO ST-1HS-2PS 47.2	4982	4982	1150	575	415
KAPPA V EVO 52.2	5350	5350	1266	633	450
KAPPA V EVO ST-1P 52.2	5350	5350	1266	633	450
KAPPA V EVO ST-2P 52.2	5354	5354	1270	637	451
KAPPA V EVO ST-1HS-2PS 52.2	5554	5554	1270	637	451
KAPPA V EVO 58.2	6017	6017	1486	743	527
KAPPA V EVO ST-1P 58.2	6017	6017	1486	743	527
KAPPA V EVO ST-2P 58.2	6021	6021	1490	747	528
KAPPA V EVO ST-1HS-2PS 58.2	6221	6221	1490	747	528
KAPPA V EVO 64.2	6495	6495	1602	801	567
KAPPA V EVO ST-1P 64.2	6495	6495	1602	801	567
KAPPA V EVO ST-2P 64.2	6499	6499	1606	805	568
KAPPA V EVO ST-1HS-2PS 64.2	6699	6699	1606	805	568
KAPPA V EVO 70.2	7073	7073	1718	859	607
KAPPA V EVO ST-1P 70.2	7073	7073	1718	859	607
KAPPA V EVO ST-2P 70.2	7077	7077	1722	863	608
KAPPA V EVO ST-1HS-2PS 70.2	7277	7277	1722	863	608
KAPPA V EVO 76.2	7551	7551	1830	917	647
KAPPA V EVO ST-1P 76.2	7551	7551	1830	917	647
KAPPA V EVO ST-2P 76.2	7555	7555	1834	921	648
KAPPA V EVO ST-1HS-2PS 76.2	7755	7755	1834	921	648
KAPPA V EVO 82.2	8029	8029	1942	971	687
KAPPA V EVO ST-1P 82.2	8029	8029	1942	971	687
KAPPA V EVO ST-2P 82.2	8033	8033	1946	975	688
KAPPA V EVO ST-1HS-2PS 82.2	8233	8233	1946	975	688
KAPPA V EVO 88.2	8507	8507	2050	1025	727
KAPPA V EVO ST-1P 88.2	8507	8507	2050	1025	727
KAPPA V EVO ST-2P 88.2	8511	8511	2054	1029	728
KAPPA V EVO ST-1HS-2PS 88.2	8711	8711	2054	1029	728
KAPPA V EVO 94.2	8985	8985	2158	1079	767
KAPPA V EVO ST-1P 94.2	8985	8985	2158	1079	767
KAPPA V EVO ST-2P 94.2	8989	8989	2162	1083	768
KAPPA V EVO ST-1HS-2PS 94.2	9189	9189	2162	1083	768
KAPPA V EVO 100.2	9459	9459	2262	1129	807
KAPPA V EVO ST-1P 100.2	9459	9459	2262	1129	807
KAPPA V EVO ST-2P 100.2	9463	9463	2266	1133	808
KAPPA V EVO ST-1HS-2PS 100.2	9663	9663	2266	1133	808

MODELLO	PIANTI DI APPESAGGIO ANTIVIBRANTI (VIBRATION DAMPER FOOT HOLDS)
G.	918
Fh	

A4B440B

KAPPA V EVO 61.2-80.2

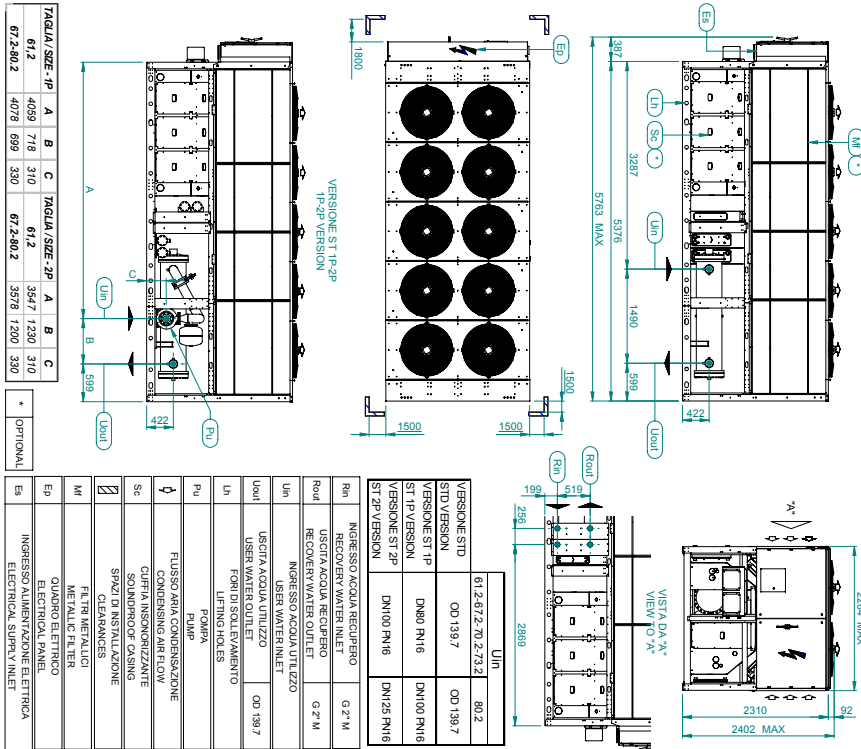

TAGLIA / SIZE - 1P	A	B	C	TAGLIA / SIZE - 2P	A	B	C
61.2	4059	718	310	61.2	3547	1230	310
67.2-80.2	4078	699	330	67.2-80.2	3597	1200	330

* OPTIONAL	EP
------------	----

Ulin	INGRESSO ACQUA RECUPERO	G 2" M
Roult	USCITA ACQUA RECUPERO	G 2" M
Ulin	INGRESSO ACQUA UTILIZZO	G 2" M
Uout	USCITA ACQUA UTILIZZO	G 2" M
Ulin	INGRESSO ACQUA RECUPERO	G 2" M
Uout	USCITA ACQUA RECUPERO	G 2" M
Ulin	INGRESSO ACQUA UTILIZZO	G 2" M
Uout	USCITA ACQUA UTILIZZO	G 2" M
Ulin	INGRESSO ACQUA RECUPERO	G 2" M
Uout	USCITA ACQUA RECUPERO	G 2" M
Ulin	INGRESSO ACQUA UTILIZZO	G 2" M
Uout	USCITA ACQUA UTILIZZO	G 2" M

G.1	PUNTI DI APPoggio ANTIVIBRANTI	018
F.H	VIBRAZIONI DAMPER HOLES	018

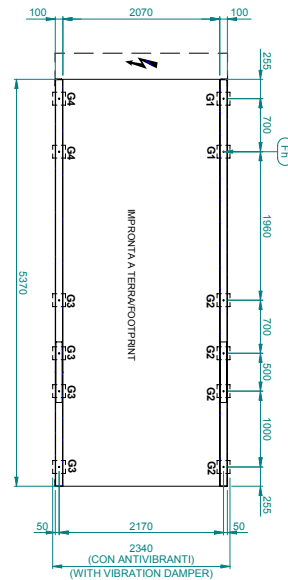

CODICE	DESCRIZIONE	VELOCITA'	PRESSIONE	RICERCA	CONFERMA	INVERTIBILE	CONFERMA	INVERTIBILE	PRESSIONE	VELOCITA'
61.2-80.2-1P	61.2-80.2-1P	2708	377	496	496	496	496	496	377	2708
61.2-80.2-2P	61.2-80.2-2P	2708	377	496	496	496	496	496	377	2708
67.2-80.2-1P	67.2-80.2-1P	2708	377	496	496	496	496	496	377	2708
67.2-80.2-2P	67.2-80.2-2P	2708	377	496	496	496	496	496	377	2708
61.2-80.2-1P-2P	61.2-80.2-1P-2P	2708	377	496	496	496	496	496	377	2708
67.2-80.2-1P-2P	67.2-80.2-1P-2P	2708	377	496	496	496	496	496	377	2708
61.2-80.2-1P-2P-2P	61.2-80.2-1P-2P-2P	2708	377	496	496	496	496	496	377	2708
67.2-80.2-1P-2P-2P	67.2-80.2-1P-2P-2P	2708	377	496	496	496	496	496	377	2708

KAPPA V EVO 1ps / 2ps 61.2-80.2

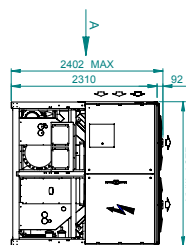
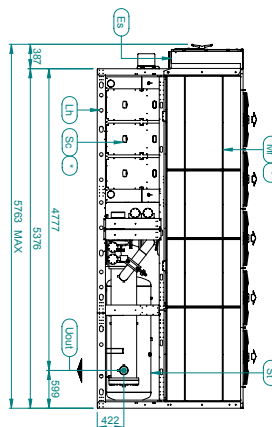
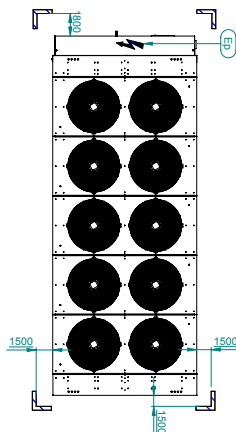
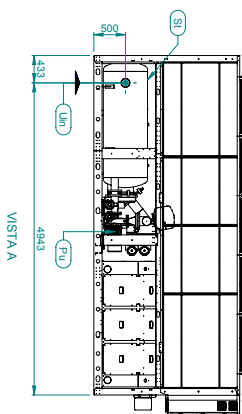

Un	INGRESSO ACQUA UTILIZZO USER WATER INLET	OPZIONALE OD 138,7
Ua1	USCITA ACQUA UTILIZZO USER WATER OUTLET	OD 138,7
St	SERBATOIO DI ACCUMULO STORAGE TANK	
Lh	FOCHI DI SOLLEVAMENTO LIFTING HOLES	
Pu	POMPA PUMP	
∅	FLUSSO ARIA CONDENSAZIONE CONDENSING AIR FLOW	
Sc	GRUPPI INSORZIZZANTE SPRING/SPROOF CASINGS	
✓	SPAZIO DI INSTALLAZIONE INSTALLATION SPACE	
Mt	GRUPPI METALLO METALLIC RITTERS	
Ep	QUADRO ELETTRICO ELECTRICAL PANEL	
Es	INGRESSO ALIMENTAZIONE ELETTRICA ELECTRICAL SUPPLY INLET	

G.	PIANTI DI APPOGGIO ANTIVIBRANTI VIBRATION DAMPER FOOT HOLDS	018
Fh	PIGNI DI FISSAGGIO FIXING HOLES	018

MODELLO	PESO(KG)	PESO IN FUNZIONE(KG)	G1(KG)	G2(KG)	G3(KG)	G4(KG)
KAPPA V EVO ST 1PS-2PS 61.2	5480	6510	701	533	449	590
KAPPA V EVO ST 1PS-2PS-LN 61.2	5878	6908	789	539	458	671
KAPPA V EVO ST 1PS-2PS-LN 67.2	5508	6538	706	537	449	591
KAPPA V EVO ST 1PS-2PS-LN 70.2	5906	6936	794	542	459	672
KAPPA V EVO ST 1PS-2PS-LN 73.2	5990	7020	813	545	460	687
KAPPA V EVO ST 1PS-2PS-LN 78.2	5574	6604	721	538	451	603
KAPPA V EVO ST 1PS-2PS 80.2	5972	7002	809	544	460	687
KAPPA V EVO ST 1PS-2PS-LN 80.2	5989	7019	795	556	467	697
KAPPA V EVO ST 1PS-2PS-LN 80.2	6394	7414	853	562	476	748

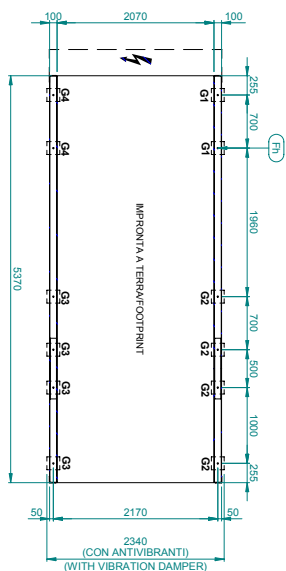

A4B491B

KAPPA V EVO 1Ps / 2Ps KAPPA V EVO 82.2-90.2

↓	FLUSSO/ARIA CONDENSAZIONE CONDENSING AIR FLOW	Un	INGRESSO ACQUA UTILIZZO USER WATER INLET	*	OPTIONAL
Sc	CUFFIA INSONDABILE SOUNDPROOF CASING	Uod	USCITA ACQUA UTILIZZO USER WATER OUTLET		00.199.7
✓	SPAZZI DI INSTALLAZIONE CLEARANCES				00.188.3
M	FILTRI METALLICI METALLIC FILTER	St	SERBATOIO DI ACCUMULO STORAGE TANK		
50	QUADRO ELETTRICO ELECTRICAL PANEL	Lh	FORI DI SOLLEVAMENTO LIFTING HOLES		
Es	INGRESSO ALIMENTAZIONE ELETTRICA ELECTRICAL SUPPLY INLET	Pu	POVERA PUMP		

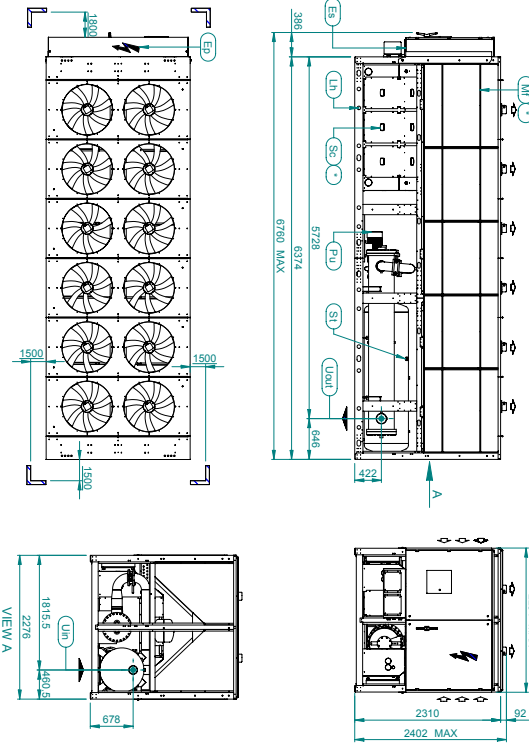

G.	PUNTI DI APOGGIO ANTIVIBRANTI VIBRATION DAMPER FOOT HOLDS	
Fh	FORI DI FISSAGGIO FIXING HOLES	Ø18

MODELLO	PESO (KG) WEIGHT (KG)	PESO IN FUNZIONE (KG) OPERATING WEIGHT (KG)	G1 (KG)	G2 (KG)	G3 (KG)	G4 (KG)
KAPPA V EVO ST 1PS-2PS LN 82.2	6166	7312	848	598	474	684
KAPPA V EVO ST 1PS-2PS 86.2	6082	7208	824	586	472	684
KAPPA V EVO ST 1PS-2PS LN 86.2	6464	7610	924	586	478	753
KAPPA V EVO ST 1PS-2PS 90.2	6170	7316	848	588	475	684
KAPPA V EVO ST 1PS-2PS LN 90.2	6568	7714	848	588	480	773

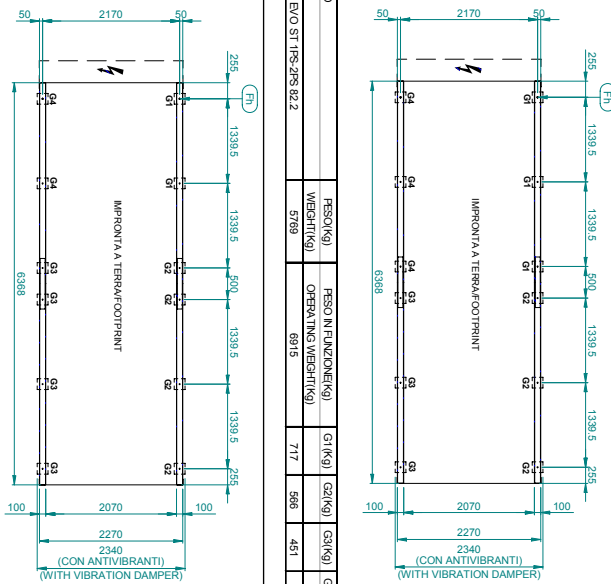

A4B493B

KAPPA V EVO 95.2-100.2

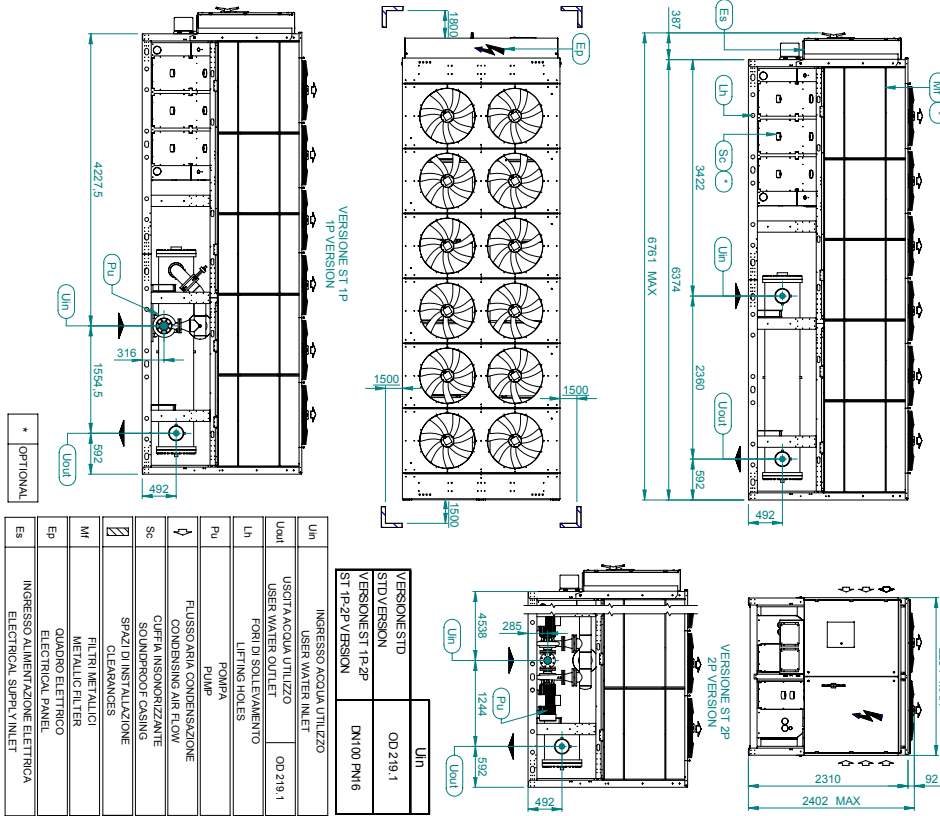

UIn	INGRESSO ACQUA UTILIZZO	OD 219.1
UoH	USCITA ACQUA UTILIZZO	OD 219.1
Lh	FORI DI SOLLEVAMENTO	
Pu	POMPA	
Sc	FLUSSO ARIA CONDENSAZIONE	
MF	GRUPPI INSORGNIZZANTE	
ES	SPAZZI DI INSTALLAZIONE	
UIn	FLUSSO ARIA CONDENSAZIONE	
UoH	CONDENSING AIR FLOW	
Lh	CUFFIA INSORGNIZZANTE	
Pu	SOUNDPROOF CASING	
Sc	CLEARANCES	
MF	FILTRI METALLICI	
ES	METALLIC FILTER	
UIn	QUADRO ELETTRICO	
UoH	ELECTRICAL PANEL	
Lh	INGRESSO ALIMENTAZIONE ELETTRICA	
Pu	ELECTRICAL SUPPLY INLET	

VERSIONE STD	UIn
VERSIONE STD VERSION	OD 219.1
VERSIONE ST-1P-2P	DN100 PN16
ST-1P-2P VERSION	

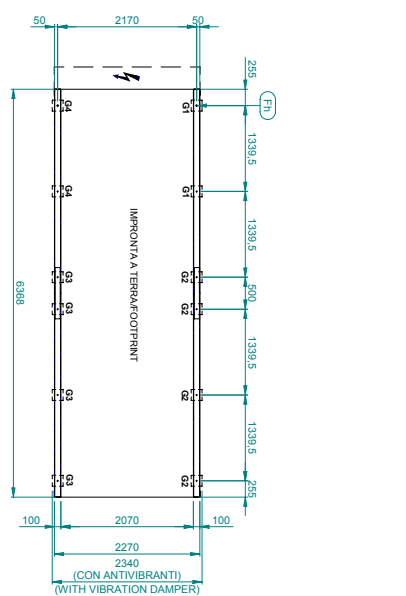

G.	PUNTI DI APPOGGIO ANTIVIBRANTI	
Fh	VIBRATION DAMPER FOOT HOLDS	Ø18
	FORI DI FISSAGGIO	
	FIXING HOLES	

MODELLO	MODEL	PESO (KG)	WEIGHT (KG)	PESO IN FUNZIONE (KG)	OPERATING WEIGHT (KG)	G (KG)	G (KG)	G2 (KG)	G2 (KG)	G3 (KG)	G4 (KG)
KAPPA V EVO 95.2	KAPPA V EVO LN 95.2	6085	6085	6504	6504	812	405	405	407	816	
KAPPA V EVO LN 95.2	KAPPA V EVO LN 95.2	6481	6481	6900	6900	907	407	409	411	911	
KAPPA V EVO ST-1P-2P 95.2	KAPPA V EVO ST-1P-2P 95.2	6487	6487	6946	6946	773	441	484	850	946	
KAPPA V EVO ST-1P-2P LN 95.2	KAPPA V EVO ST-1P-2P LN 95.2	6889	6889	7348	7348	866	445	486	850	946	
KAPPA V EVO 100.2	KAPPA V EVO LN 100.2	6271	6271	6690	6690	839	411	417	850	945	
KAPPA V EVO LN 100.2	KAPPA V EVO LN 100.2	6673	6673	7092	7092	933	414	420	894	984	
KAPPA V EVO ST-1P-2P 100.2	KAPPA V EVO ST-1P-2P 100.2	6991	6991	7440	7440	800	448	495	894	984	
KAPPA V EVO ST-1P-2P LN 100.2	KAPPA V EVO ST-1P-2P LN 100.2	7083	7083	7532	7532	892	451	496	980	980	

A4B494B

KAPPA V EVO 1Ps / 2Ps 95.2-100.2

∅	FLUSSO ARIA CONDENSAZIONE CONDENSING AIR FLOW	+	OPTIONAL
Sc	CUFFIA INSONORIZZANTE SOUNDPROOF CASING	Uin	INGRESSO ACQUA UTILIZZO USER WATER INLET
2	SPAZZI DI INSTALLAZIONE CLEARANCES	Uout	USCITA ACQUA UTILIZZO USER WATER OUTLET
Mi	FILTRI METALLICI METALLIC FILTER	SI	SERBATOIO DI ACCUMULO STORAGE TANK
Ep	QUADRO ELETTRICO ELECTRICAL PANEL	Lh	FORI DI SOLELEVAMENTO LIFTING HOLES
Es	INGRESSO ALIMENTAZIONE ELETTRICA ELECTRICAL SUPPLY INLET	Fu	POMPA PUMP

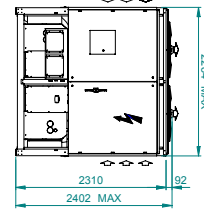
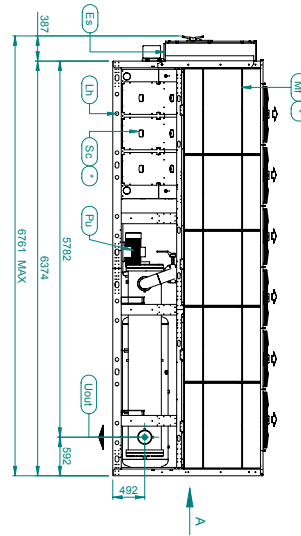
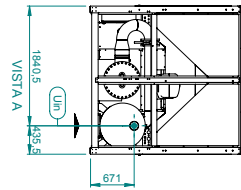
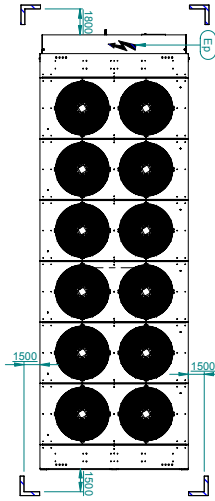

6.	PUNTI DI APPoggio ANTIVIBRANTI VIBRATION DAMPER FOOT HOLDS	Fh	978
----	---	----	-----

MODELLO	PESO (KG)	PESO IN FUNZIONE (KG)	GH (KG)	GG (KG)	GS (KG)	GH (KG)
KAPPA V EVO ST 1PS-2PS-1 IN 95.2	7261	8378	934	631	573	847
KAPPA V EVO ST 1PS-2PS-1 IN 100.2	7253	8570	981	639	594	880

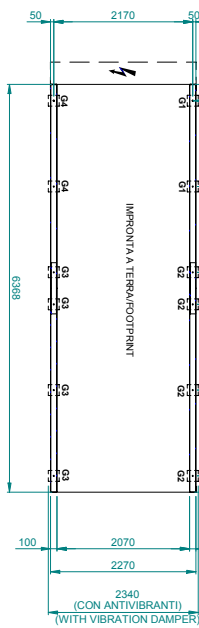

MODELLO	PESO (KG)	PESO IN FUNZIONE (KG)	GH (KG)	GG (KG)	GS (KG)	GH (KG)
KAPPA V EVO ST 1PS-2PS-2 IN 95.2	6686	7983	797	601	543	720
KAPPA V EVO ST 1PS-2PS-2 IN 100.2	6682	8189	820	604	551	748

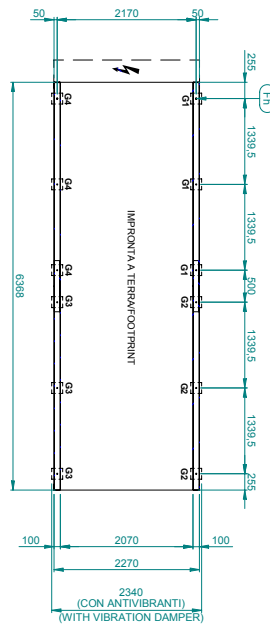

A4B495B

KAPPA V EVO 105.2-110.2

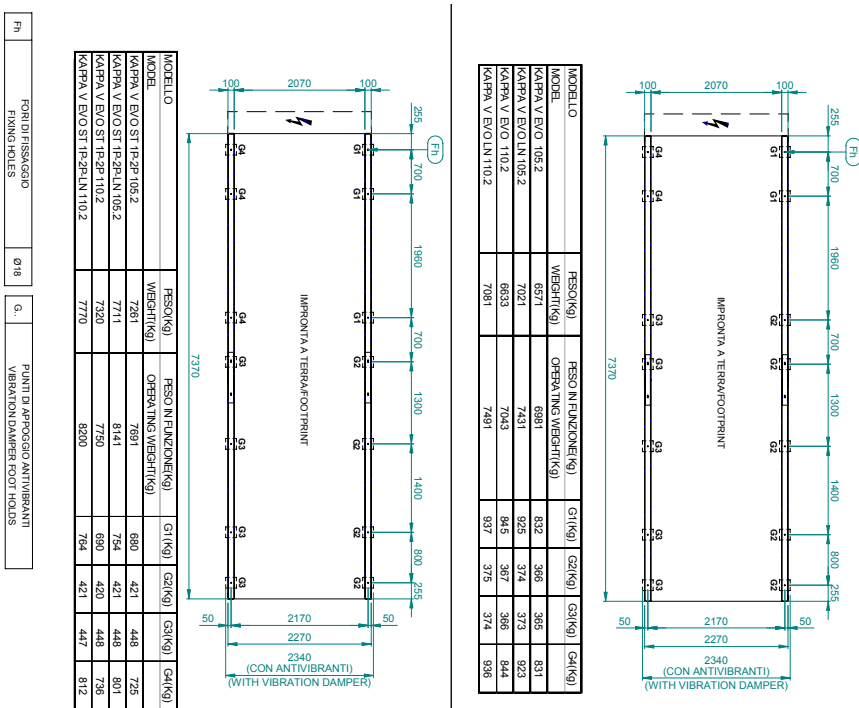
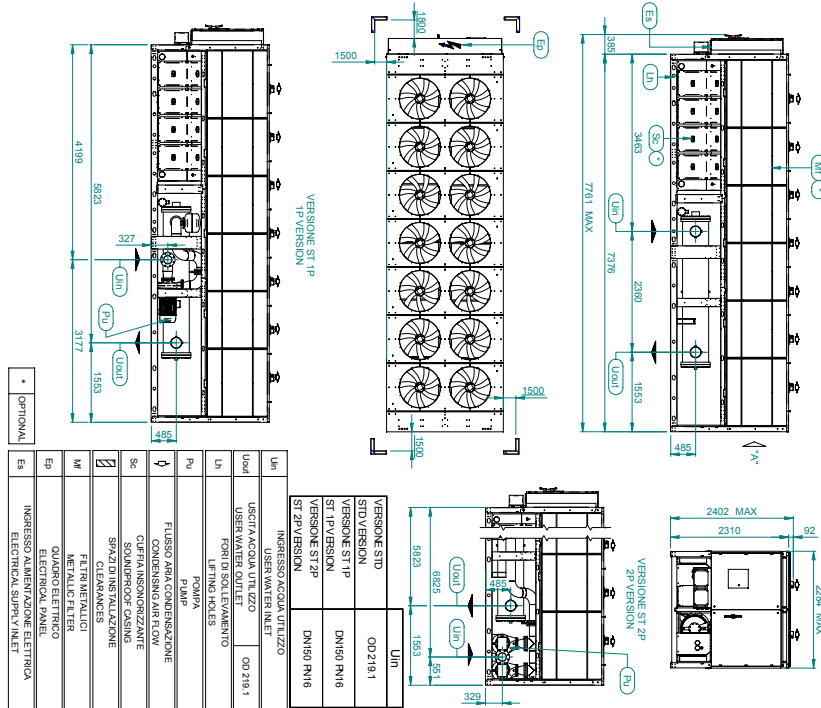

A4B496C

KAPPA V EVO 1PS / 2PS 105.2-110.2

Um	INGRESSO ACQUA UTILIZZO USER WATER INLET	001 68.3		
Uout	USCITA ACQUA UTILIZZO USER WATER OUTLET	002 19.1	SI	SERRATOIO DI ACCUMULO STORAGE TANK
Lh	FORI DI SOLTLEVAMENTO LIFTING HOLES		Pu	POMPA PUMP
M	FILTRI METALLICI METALLIC FILTER		↓	FILTRAZIONE ARIA CONDENSING AIR FLOW
Ep	QUADRO ELETRICO ELECTRICAL PANEL		Se	CURTA INSONORIZZANTE SOUNDPROOF CASING
Es	INGRESSO ALIMENTAZIONE ELETTRICA ELECTRICAL SUPPLY INLET		☑	SPAZI DI INSTALLAZIONE CLEARANCES

SIZE

OPTIONAL

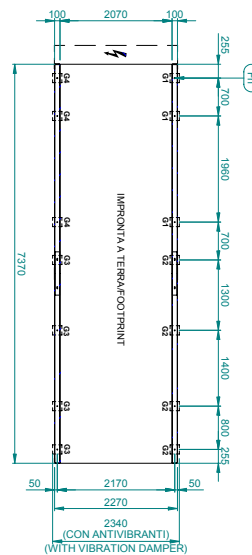
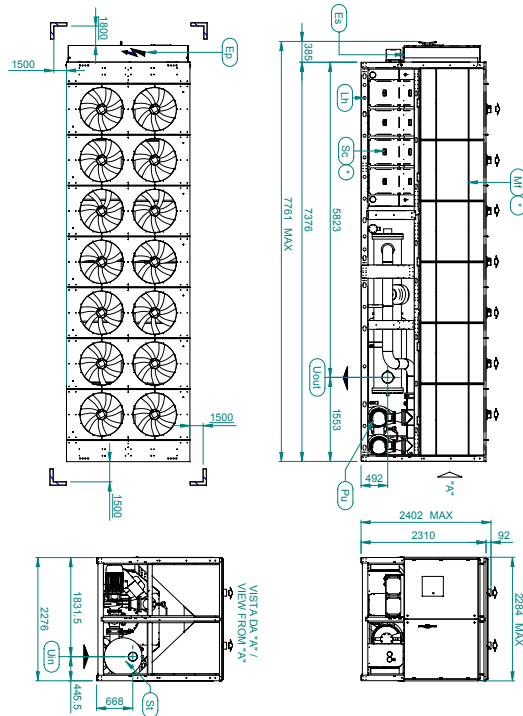

MODELLO MODEL	PESO(KG) WEIGHT(KG)	PESO IN FUNZIONE(KG) OPERATING WEIGHT(KG)	G1(KG)	G2(KG)	G3(KG)	G4(KG)
KAPPAV EVO ST 1PS-2PS 105.2	7431	8729	714	597	554	661
KAPPAV EVO ST 1PS-2PS-1N 105.2	7882	9180	790	597	555	734
KAPPAV EVO ST 1PS-2PS 110.2	7487	8785	724	597	553	671
KAPPAV EVO ST 1PS-2PS-1N 110.2	7941	9239	800	596	555	745

G.	PUNTI DI APPOGGIO ANTIVIBRANTI VIBRATION DAMPER FOOT HOLDS	
Fh	FORI DI FISSAGGIO FIXING HOLES	Ø18

A4B425B

KAPPA V EVO 1PS / 2PS 115.2-140.2

SI	SERRATORIO DI ACCUMULO STORAGE TANK	Sc	CUFFIA INSONORIZZANTE SOUNDPROOF CASING
Un	INGRESSO ACQUA UTILIZZO USER WATER INLET	OD 168.3	
Uoal	USCITA ACQUA UTILIZZO USER WATER OUTLET	OD 219.1	Spazi di installazione CLEANANCES
∅	FLUSSO ARIA CONDENSAZIONE CONDENSING AIR FLOW	MI	FILTRI METALLICI METALLIC FILTER
Lh	FORI DI SOTTILEVAMENTO LIFTING HOLES	Ep	QUADRO ELETTRICO ELECTRICAL PANEL
Pu	POMPA PUMP	Es	INGRESSO ALIMENTAZIONE EL. ELETTRICA ELECTRICAL SUPPLY INLET
		*	OPTIONAL

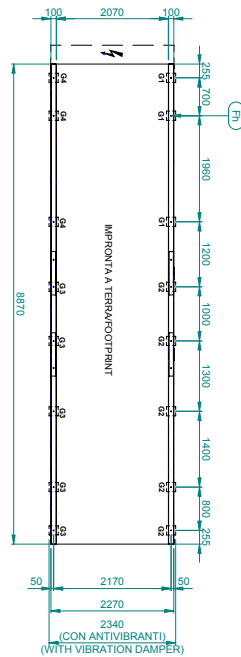
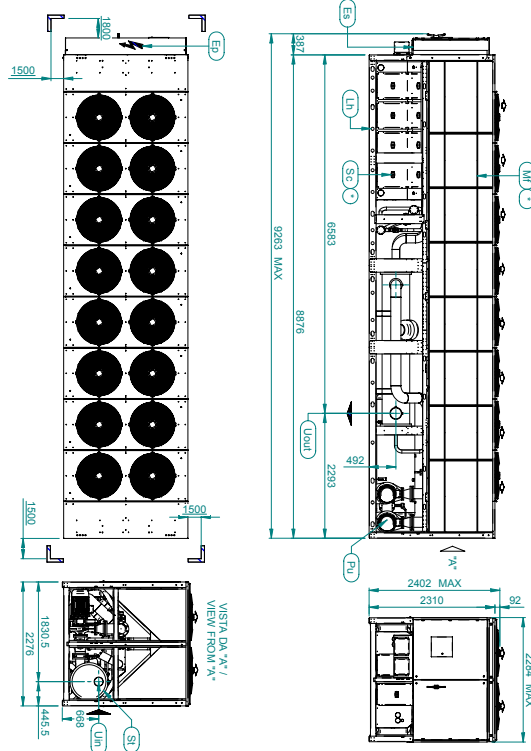

MODELLO	FESQ (kg)	FESQ IN FUNZIONE (kg)	GT (kg)	CS2 (kg)	CS3 (kg)	CS4 (kg)
KAPPA V EVO 115.2 CH 1PS-2PS	862	1002	828	527	488	741
KAPPA V EVO 115.2 CH 1PS-2PS LN	862	1002	828	527	488	741
KAPPA V EVO 120.2 CH 1PS-2PS LN	874	1014	840	539	499	753
KAPPA V EVO 120.2 CH 1PS-2PS LN	874	1014	840	539	499	753
KAPPA V EVO 130.2 CH 1PS-2PS LN	903	1043	869	568	528	782
KAPPA V EVO 130.2 CH 1PS-2PS LN	903	1043	869	568	528	782
KAPPA V EVO 140.2 CH 1PS-2PS LN	942	1082	908	607	567	821
KAPPA V EVO 140.2 CH 1PS-2PS LN	942	1082	908	607	567	821
KAPPA V EVO 140.2 CH 1PS-2PS LN	915	1047	881	580	541	800
KAPPA V EVO 140.2 CH 1PS-2PS LN	915	1047	881	580	541	800

Fh	FORI DI FISSAGGIO FIXING HOLES	918	q.	PUNTI DI APPoggio ANTIVIBRANTI VIBRATION DAMPENER HOLES
----	-----------------------------------	-----	----	--

A4B892C

KAPPA V EVO 150.4-180.4

Sc	CUFFIA INSONORIZZANTE SOUNDPROOF CASING	Pu	POMPA PUMP
Lh	FORI DI ISOLEVAMENTO LIFTING HOLES	Un	INGRESSO ACQUA UTILIZZO USER WATER INLET
Mi	FILTRI METALLICI METALLIC FILTER	Uol	USCITA ACQUA UTILIZZO USER WATER OUTLET
Ep	QUADRO ELETTRICO ELECTRICAL PANEL		FLUSSO ARIA CONDENSAZIONE CONDENSING AIR FLOW
Ea	INGRESSO ALIMENTAZIONE ELETTRICA ELECTRICAL SUPPLY INLET		SPAZZI D'INSTALLAZIONE CLEARANCES

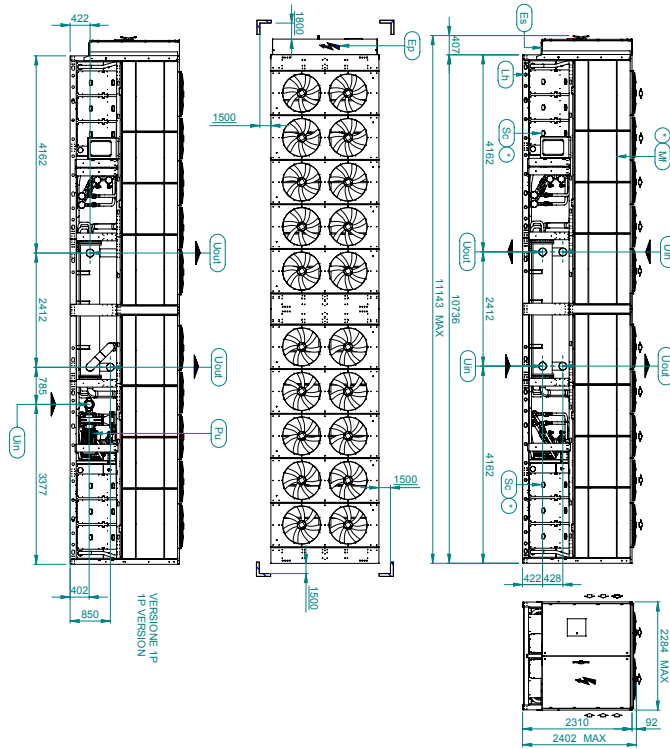

G	PUNTI DI APPOGGIO ANTIVIBRANTI VIBRATION DAMPER FOOT HOLDS
Fh	FORI DI ISSAGGIO FRINGING HOLES

MODELLO	PESO (KG)	PESO IN FUNZIONE (KG)	RESO IN FUNZIONE (KG)	G1 (KG)	G2 (KG)	G3 (KG)	G4 (KG)
KAPPA V EVO 150.4	10073	10584	653	630	630	633	633
KAPPA V EVO LN 150.4	10873	11384	743	680	680	743	743
KAPPA V EVO ST-IP 150.4	10819	11240	755	688	638	648	648
KAPPA V EVO ST-PLN 150.4	11415	12038	805	617	699	698	738
KAPPA V EVO 180.4	10889	11780	744	655	654	735	735
KAPPA V EVO LN 180.4	11489	11980	798	708	704	785	785
KAPPA V EVO ST-IP 180.4	11219	11680	806	697	662	695	695
KAPPA V EVO ST-PLN 180.4	12335	12836	895	646	733	646	646
KAPPA V EVO LN 180.4	12112	12412	821	756	721	816	816
KAPPA V EVO ST-IP 180.4	11652	12082	833	623	680	622	622
KAPPA V EVO ST-PLN 180.4	12462	13072	884	673	740	871	871

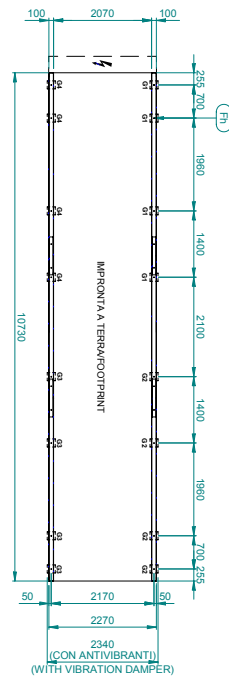

AB367C

KAPPA V EVO A

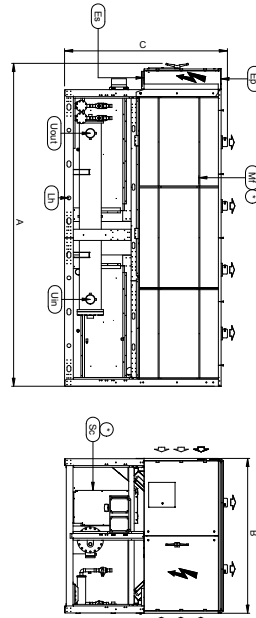

Un	INGRESSO ACQUA UTILIZZO USCITA ACQUA UTILIZZO USCITA ACQUA UTILIZZO
Un	USCITA ACQUA UTILIZZO
MI	FILTRIMETALICO FILTRIMETALICO
MI	QUINTINO ELETTRICO QUINTINO ELETTRICO
ES	INGRESSO ALIMENTAZIONE ELETTRICA ELETTRICAL SUPPLY INLET
Un	FORNO DI SOLELEVAMENTO LETTING LINES
↓	FLUSSO ARIA CONDENSAZIONE CONDENSATION AIR FLOW
SC	GEFFANCONCORZANTE SCALEPANOOR CASING
-	OPZIONALE

MODELLO/MODEL	A	B	C	PESON/FUNZIONE /OPERATING WEIGHT (KG)
KAPPA V EVO A 23.1	3246	2315	2402	2890
KAPPA V EVO A 23.2	3246	2315	2402	2710
KAPPA V EVO A 25.1	3246	2315	2402	2840
KAPPA V EVO A 25.2	3246	2315	2402	2990
KAPPA V EVO A 28.1	4263	2284	2402	2890
KAPPA V EVO A 28.2	4263	2284	2402	3190
KAPPA V EVO A 31.1	4263	2284	2402	3090
KAPPA V EVO A 31.2	4263	2284	2402	3400
KAPPA V EVO A 33.2	4263	2284	2402	3610
KAPPA V EVO A 35.2	4761	2284	2402	3790
KAPPA V EVO A 37.2	4761	2284	2402	3890
KAPPA V EVO A 40.2	4761	2284	2402	3900
KAPPA V EVO A 43.2	4761	2284	2402	4050
KAPPA V EVO A 47.2	5763	2284	2402	4420
KAPPA V EVO A 51.2	5763	2284	2402	4590
KAPPA V EVO A 54.2	5763	2284	2402	4520
KAPPA V EVO A 61.2	5763	2284	2402	5220
KAPPA V EVO A 70.2	6760	2284	2402	5400
KAPPA V EVO A 73.2	6760	2284	2402	5390
KAPPA V EVO A 80.2	6760	2284	2402	5470
KAPPA V EVO A 82.2	6760	2284	2402	6090
KAPPA V EVO A 85.2	6760	2284	2402	6290
KAPPA V EVO A 90.2	7761	2284	2402	7010
KAPPA V EVO A 95.2	7761	2284	2402	7120
KAPPA V EVO A 100.2	9263	2284	2402	7190
KAPPA V EVO A 105.2	9263	2284	2402	7690
KAPPA V EVO A 115.2	9263	2284	2402	7750
KAPPA V EVO A 120.2	11143	2284	2402	9610
KAPPA V EVO A 130.2	11143	2284	2402	9690
KAPPA V EVO A 140.2	11143	2284	2402	10160
KAPPA V EVO A 150.2	11143	2284	2402	10710

MODELLO/MODEL	A	B	C	PESON/FUNZIONE /OPERATING WEIGHT (KG)
KAPPA V EVO A SLN 23.1	3246	2315	2402	2810
KAPPA V EVO A SLN 23.2	3246	2315	2402	3160
KAPPA V EVO A SLN 25.1	3246	2315	2402	2970
KAPPA V EVO A SLN 25.2	3246	2315	2402	3510
KAPPA V EVO A SLN 28.1	4263	2284	2402	3090
KAPPA V EVO A SLN 28.2	4263	2284	2402	3800
KAPPA V EVO A SLN 31.1	4263	2284	2402	3280
KAPPA V EVO A SLN 31.2	4263	2284	2402	3850
KAPPA V EVO A SLN 33.2	4263	2284	2402	4060
KAPPA V EVO A SLN 35.2	4761	2284	2402	4240
KAPPA V EVO A SLN 37.2	4761	2284	2402	4310
KAPPA V EVO A SLN 40.2	4761	2284	2402	4500
KAPPA V EVO A SLN 43.2	4761	2284	2402	4500
KAPPA V EVO A SLN 47.2	5763	2284	2402	4870
KAPPA V EVO A SLN 51.2	5763	2284	2402	5040
KAPPA V EVO A SLN 54.2	5763	2284	2402	4970
KAPPA V EVO A SLN 61.2	5763	2284	2402	5670
KAPPA V EVO A SLN 70.2	6760	2284	2402	5850
KAPPA V EVO A SLN 73.2	6760	2284	2402	5830
KAPPA V EVO A SLN 80.2	6760	2284	2402	6120
KAPPA V EVO A SLN 82.2	6761	2284	2402	7320
KAPPA V EVO A SLN 85.2	6761	2284	2402	7510
KAPPA V EVO A SLN 90.2	7761	2284	2402	7620
KAPPA V EVO A SLN 95.2	9263	2284	2402	8150
KAPPA V EVO A SLN 100.2	9263	2284	2402	8290
KAPPA V EVO A SLN 105.2	9263	2284	2402	8390
KAPPA V EVO A SLN 115.2	11143	2284	2402	10360
KAPPA V EVO A SLN 120.2	11143	2284	2402	10600
KAPPA V EVO A SLN 130.2	11143	2284	2402	10600
KAPPA V EVO A SLN 140.2	11143	2284	2402	10650

A4D122

PRACTICAL RECOMMENDATIONS FOR INSTALLATION

POSITIONING

Verify that there are no obstructions on the suction of the louvered coil and on the fans flow.

Position the unit in order to reduce to a minimum the environmental impact (sound emission, integration with present structures, etc.).

ELECTRIC CONNECTIONS

Always consult the attached electric layout, where all necessary instructions to carry out the Electric connections are reported.

Apply voltage to the unit (closing the isolating device) at least 12 hours before start-up to allow power supply of the sump resistances.

Do not remove the voltage to the resistances during the unit brief standstill periods.

Before opening the isolating device, stop the unit by acting on the appropriate start switches, or in absence, on the remote control.

Before accessing the internal parts of the unit, disconnect by opening the main isolating device.

The power supply line must be protected in compliance with that provided in the regulations in force.

Electric connections to be carried out: three polar power cable + earth, or three polar cable + neutral+ earth; external consent; remote alarm report.

HYDRAULIC CONNECTIONI

Accurately remove the hydraulic plant, with pumps switched off, by acting on the small vent valves. This procedure is particularly important in that, even the smallest air bubbles can cause the evaporator to freeze.

Discharge the water plant during the winter breaks or use appropriate anti-freezing mix. In case of brief period of time of unit stop, the installation of the anti-freeze resistance on the evaporator and on the hydraulic circuit is recommended.

Realise the hydraulic circuit including the components indicated in the recommended layouts (expansion tank, flow switch, storage tank, vent valves, shut-off valve, anti vibration joints, etc. See use installation and maintenance manual.

Connect the flow meter in the units for which it is supplied, carefully following the instructions attached to the same unit.

START-UP AND MAINTENANCE

Carefully keep to that indicated in the use and maintenance manual. Such operations must be carried out by qualified staff.



Swegon operation s.r.l.
via Valletta,5 - 30010 Cantarana di Cona (VE) - Italy
tel. +39 0426 921111 - fax +39 0426 302222
www.blueboxgroup.it

BlueBox 
by Swegon