

Air cooled chillers and heat pumps

McSmart 160 ÷ 500

from 48 to 155 kW

HFC 407C

ECOLOGICAL REFRIGERANT



McQuay is participating in the Eurovent Certification Programme. Product are as listed in the Eurovent Directory of Certified Products and on the web site www.eurovent-certification.com



INDEX

McSmart 160÷500	page	3
General characteristics	page	4
Accessories	page	6
Operating limits	page	7
Performance adjustment factors	page	7
Technical data	page	8
Sound levels	page	10
Capacity performance	page	11
Refrigerant and hydraulic circuits	page	16
Installation	page	18
- Handling and space requirements	page	18
- Dimensions	page	19
- Electric wiring data	page	21
- Water circuit	page	22
- Evaporator pressure drops	page	23
- Water pump available lift	page	24
- Pumps data	page	24
Maintenance	page	25
Safety	page	26

McSmart 160 + 500

McSmart is the solution for residential and commercial applications.

It is available in 7 sizes from 48 to 155 kW, in cooling only and heat pump versions, with R407C ecological refrigerant.

It has been designed for high energy efficiency. The low noise emission meets every requirement for installation in residential areas.

The microprocessor is compatible with Smart Manager, the McQuay solution that allows to control up to 50 chillers and 256 fan coils. McQuay is able to cover the complete hydronic system with McSmart chillers and fan coils series.



MF series



MWM series



MCK series



MCW series



MCC series



General characteristics

Cabinet and structure

The cabinet is made of galvanized steel sheet and painted to provide a high resistance to corrosion. The base frame has holes for easy moving by fork lift. The weight is uniformly distributed along the profiles of the base and this facilitates the arrangement of the unit's bases and the support structures. The electrical and control equipment is located in the control box.

Scroll compressors

The scroll compressors achieve a high volumetric efficiency, due to constant contact with the sides of the scroll spirals and the total absence of discharge and suction valves. These compressors are not only extremely reliable thanks to the reduced number of moving parts, but have an exceptionally low noise level because of the absence of suction and discharge valves and hence of the reduced pulsations of the discharge gas. The reduction in moving parts means a very low level of vibration.

Evaporator

The evaporator is a compact, efficient, dual circuit plate to plate type heat exchanger consisting of stainless steel brazed plates.

The evaporator is wrapped with closed cell heat insulation and equipped with an heater for protection against freezing down to -29°C .

Condenser coils

The condenser coils are made of internally enhanced seamless copper tubes arranged in a staggered row pattern and mechanically expanded into lanced and rippled aluminium condenser fins with full fin collars.

Condenser coil fans

The condenser fans are axial helical type; the blades profile is optimised to achieve the best performance. The direct coupling with the electrical motor eliminates the problems related to transmission devices and reduces the vibrations caused by the functioning. The motors are supplied as standard with IP54 protection and are mono-phase external rotor type; they are protected against overload by thermal relays located inside the electrical control panel.

Electrical panel

The panel is manufactured to ensure protection in all weather conditions (IP 54). It complies with IEC204-1 safety norms. The power panel is fitted with a door interlocked mains isolator to prevent access. The power section includes thermal relays for compressors and fans.

Control devices

The microprocessor controller can be used either as a single stand-alone or as an extended network system. The control panel consists of a main board and a wired remote keypad with 8 lines graphical LCD display. The 8 available keys in the panel allow the user to do the following tasks:

- Menu selection
- Navigation on the screen
- Modification of the selected value

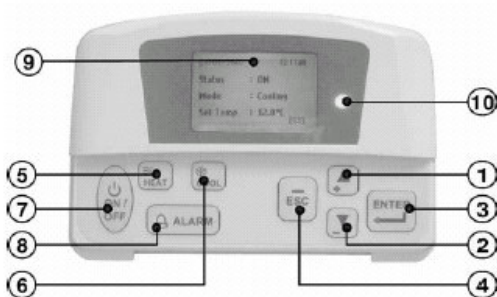

1 & 2	Navigator key
3	Execute instruction key
4	Cancel instruction key
5	Switching to heat mode shortcut key
6	Switching to cool mode shortcut key
7	Toggle ON/OFF shortcut key
8	Show alarm key
9	Graphical LCD display
10	ON/OFF indicator

During start-up, the panel will have a default configuration (timer schedule, set point, settings, etc) which can be later modified by the user.

Main characteristics

Status viewing:

- ON/OFF status
- Operating mode (cooling/heating/boiler)
- Set temperature
- Compressor status (ON/OFF/DEFROST)
- Inlet water, outlet water, outdoor air and panel temperatures
- Advance parameter settings
- Defrost sensor temperatures
- Compressor discharge sensor temperatures
- Compressor run time
- Incoming alarm/fault/error

Status settings:

- ON/OFF switching
- Operating mode setting (cooling/heating/boiler)
- Setting temperature
- Manual entering defrost
- Advance parameter settings
- Password changing
- Panel option setting (backlight, alarm buzzer, screen saver, contrast, brightness, temperature unit)
- Time and date settings
- 7 day programmable settings
- Compressor run time reset

Menu structure

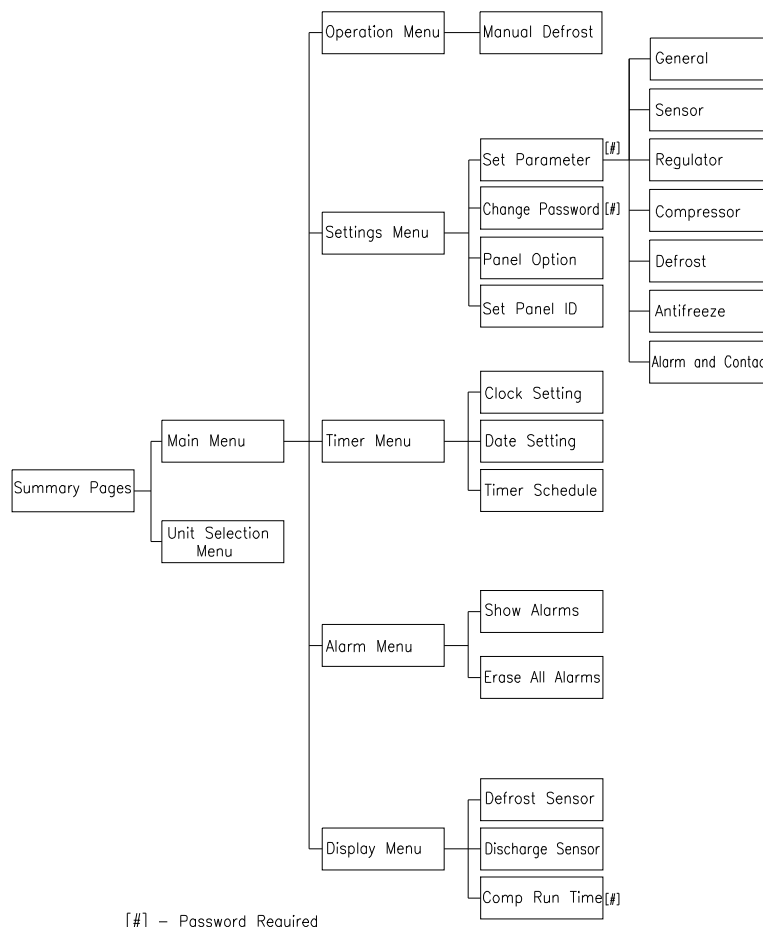

Standards reference

Every unit is designed, manufactured, tested according to CE marked.

Quality management system is approved by RINA in compliance with UNI - EN ISO 9001:2000 standards.

Accessories

Standard accessories

Fan thermal overload relays – safety devices against fans motor overload.

Compressor thermal overload relays – safety devices against compressor motor overload.

Phase monitor – safety device against reversal of phase.

Condenser coil guards – metal protection guards fixed on the external surface of the condenser coils.

Compressor coil guards – metal protection guards to prevent unauthorised access to the components under the condenser coils section.

Water pressure differential switch – safety device against missing evaporator water flow.

Manometers – gauges for high gas pressure and low gas pressure.

Vibration-dampings – rubber type for 160÷240 unit models, spring type for 320÷500 unit models.

Options on request

Low ambient kit - device that allows fan speed modulation, modifying air flow according to external temperature conditions down to -10°C.

Two water circulation pumps kit (factory unit mounted) – with the following components.

Water pumps: each unit has two water pumps as option, with a selection switch to chose which one to run. Maximum working pressure is 6 bar.

Filling valve: auto-operated to fill water whenever the water pressure is lower due to water absence.

Air vent: to vent air in the hydraulic circuit.

Safety valve: acts whenever faulty service leads to an operating pressure in the hydraulic circuit that exceeds the valve opening value.

Expansion tank: 8 l for 160÷320 unit models, 18 l for 400÷500 unit models; it absorbs volume variation in the water circuit.

Stop valves: installed on both water pump inlet and outlet.

Water filter: installed before the water pump, retains impurities.

Purge valve: drain for maintenance.

Manometer: installed on the filling valve to display the water pressure for circuit.

Operating limits

OPERATING LIMITS	Cooling only	Heat pump
Ambient air		
Maximum temperature in cooling mode	+48 °C	+48 °C
Minimum temperature in cooling mode for McSmart 160÷240	+12 °C (1)	+12 °C (1)
Minimum temperature in cooling mode for McSmart 320÷500	+15 °C (1)	+15 °C (1)
Maximum temperature in heating mode		+26 °C
Minimum temperature in heating mode		-7 °C
Evaporator water		
Maximum outlet temperature in cooling mode	+10 °C	+10 °C
Minimum outlet temperature without glycol in cooling mode	+5 °C	+5 °C
Minimum outlet temperature with glycol in cooling mode	-8 °C	-8 °C
Maximum outlet temperature in heating mode		+55 °C
Minimum outlet temperature in heating mode		+35 °C
Maximum ΔT	8 °C	8 °C
Minimum ΔT	4 °C	4 °C

(1) -10 °C with low ambient kit option.

Performance adjustment factors

Evaporator fouling factors

Fouling factors m ² °C / kW	Cooling capacity correction factor	Power input correction factor	COP correction factor
0,0176	1,000	1,000	1,000
0,0440	0,978	0,986	0,992
0,0880	0,957	0,974	0,983
0,1320	0,938	0,962	0,975

Altitude correction factors

Elevation above sea level (m)	0	300	600	900	1200	1500	1800
Barometric pressure (mbar)	1013	977	942	908	875	843	812
Cooling cap. correction factor	1,000	0,993	0,986	0,979	0,973	0,967	0,960
Power input correction factor	1,000	1,005	1,009	1,015	1,021	1,026	1,031

Ethylene glycol and low ambient temperature correction factors

Air ambient temperature °C	-3	-8	-15	-23	-35
% of ethylene glycol by weight	10	20	30	40	50
Cooling capacity correction factor	0,991	0,982	0,972	0,961	0,946
Power input correction factor	0,996	0,992	0,986	0,976	0,966
Flow rate correction factor	1,013	1,040	1,074	1,121	1,178
Water pressure drop correction factor	1,070	1,129	1,181	1,263	1,308

Low temperature operation performance factors

Ethylene glycol/water leaving temperature °C	2	0	-2	-4	-6	-8
Max air ambient temperature °C	40	39	38	37	36	35
Cooling capacity correction factor	0,842	0,785	0,725	0,670	0,613	0,562
Power input compressors correction factor	0,95	0,94	0,92	0,89	0,87	0,84
Min. % of ethylene glycol	10	20	20	30	30	30

Low temperature operation performance factors must be applied to the nominal performance data to have the adjusted value (12/7 °C, design ambient temperature).

Technical data

Cooling only

McSmart		160C	190C	210C	240C	320C	400C	500C
Cooling capacity (1)	kW	47,8	57,9	70,5	81,2	98,0	124,3	154,8
Power input (1)	kW	18,4	21,1	24,2	28,6	37,5	42,4	52,3
COP		2,60	2,74	2,91	2,84	2,61	2,93	2,96
Compressor		Scroll						
Quantity		2	2	2	2	4	4	4
Total oil charge	l	6,5	6,5	8,0	13,0	13,0	13,0	26,4
Reduction steps number		2	2	2	2	4	4	4
Refrigerant		R407C						
Circuits number		2	2	1	1	2	2	2
Charge	kg	12,6	14,0	22,0	20,5	29,0	48,0	64,0
Condenser coil		Lanced fins – internally spiral wound tubes						
Fan		Helical						
Quantity		2	2	2	2	2	4	4
Power input	kW	0,72	0,72	0,72	0,72	1,90	0,72	0,72
Speed	RPM	715	715	715	715	715	715	715
Diameter	mm	710	710	800	800	800	800	800
Evaporator		Plate heat exchanger						
Quantity		1	1	1	1	1	1	1
Water volume	l	8,0	9,5	10,0	12,8	12,3	18,0	25,5
Maximum water pressure	bar	30	30	30	30	30	30	30
Water connections diameter	"	Rc 1 1/2	Rc 1 1/2	Rc 1 1/2	Rc 1 1/2	Rc 2	Rc 2	Rc 2
Dimensions and weight								
Length	mm	1820	1820	2056	2056	2750	2750	2750
Width	mm	1000	1000	1153	1153	1100	2200	2200
Height	mm	1935	1935	2185	2185	2180	2180	2180
Standard unit shipping weight	kg	637	651	843	906	1155	1543	1899
Standard unit operating weight	kg	650	666	864	942	1175	1571	1935
Shipping weight with pumps kit	kg	661	675	878	941	1190	1580	2055
Operating weight with pumps kit	kg	674	690	899	977	1210	1607	2092
Electrical data		400 V – 3ph + N – 50 Hz						
Standard voltage (2)		400 V – 3ph + N – 50 Hz						
Nominal unit current (1) (3)	A	32,8	36,7	43,2	50,1	69,8	76,7	100,5
Maximum compressors current (4)	A	34,8	41,0	47,8	56,6	75,6	80,4	108,0
Maximum water pump current	A	3,1	3,1	5,4	5,4	5,4	6,4	8,5
Maximum fans current	A	4,2	4,2	6,2	6,2	7,0	12,4	12,4
Maximum unit current (3) (4)	A	40,9	47,1	53,9	62,7	82,5	91,5	116,8
Maximum unit inrush current (5)	A	116,7	135,3	155,7	182,1	159,5	174,7	217,2
Maximum unit current for wires sizing (6)	A	54,8	63,6	73,1	85,4	105,0	112,4	136,2

- (1) Nominal cooling capacity and power input are based on: 12/7 °C entering/leaving evaporator water temperature; 35°C ambient temperature.
- (2) Allowed voltage tolerance $\pm 10\%$. Voltage unbalance between phases must be within $\pm 3\%$.
- (3) Without pump.
- (4) Maximum current are based on: 15/10 °C entering/leaving evaporator water temperature and 48°C ambient temp.
- (5) Inrush current of biggest compressor + nominal absorbed current of the other compressors + fans current.
- (6) Compressor FLA + fans current.

Technical data

Heat pump

McSmart		160CR	190CR	210CR	240CR	320CR	400CR	500CR
Cooling capacity (1)	kW	47,1	52,9	63,6	75,6	96,0	112,6	144,7
Power input (1)	kW	18,3	20,1	23,4	27,1	35,5	41,0	50,7
Heating capacity (2)	kW	55,1	57,1	67,2	81,8	110,3	118,1	157,5
Power input (2)	kW	19,5	20,7	25,6	28,5	38,1	45,4	57,3
COP (1)		2,57	2,63	2,72	2,79	2,70	2,75	2,85
Compressor		Scroll						
Quantity		2	2	2	2	4	4	4
Total oil charge	l	6,5	6,5	8,0	13,0	13,0	13,0	26,4
Reduction steps number		2	2	2	2	4	4	4
Refrigerant		R407C						
Circuits number		2	2	1	1	2	2	2
Charge	kg	13,0	15,0	26,0	26,0	42,0	42,0	56,0
Condenser coil		Lanced fins – internally spiral wound tubes						
Fan		Helical						
Quantity		2	2	2	2	2	4	4
Power input	kW	0,72	0,72	0,72	0,72	1,90	0,72	0,72
Speed	RPM	715	715	715	715	715	715	715
Diameter	mm	710	710	800	800	800	800	800
Evaporator		Plate heat exchanger						
Quantity		1	1	1	1	1	1	1
Water volume	l	8,0	9,5	10,0	12,8	12,3	18,0	25,5
Maximum water pressure	bar	30	30	30	30	30	30	30
Water connections diameter	"	Rc 1 1/2	Rc 1 1/2	Rc 1 1/2	Rc 1 1/2	Rc 2	Rc 2	Rc 2
Dimensions and weight								
Length	mm	1820	1820	2056	2056	2750	2750	2750
Width	mm	1000	1000	1153	1153	1100	2200	2200
Height	mm	1935	1935	2185	2185	2180	2180	2180
Standard unit shipping weight	kg	650	676	885	928	1206	1583	1988
Standard unit operating weight	kg	663	691	906	964	1226	1611	2024
Shipping weight with pumps kit	kg	674	700	920	963	1241	1620	2154
Operating weight with pumps kit	kg	687	715	941	999	1261	1648	2190
Electrical data								
Standard voltage (3)		400 V – 3ph + N – 50 Hz						
Nominal unit current (1) (4)	A	32,6	35,8	41,9	49,7	66,1	74,2	97,4
Maximum compressors current (5)	A	34,8	41,0	47,8	56,6	75,6	80,4	108,0
Maximum water pump current	A	3,1	3,1	5,4	5,4	5,4	6,4	8,5
Maximum fans current	A	4,2	4,2	6,2	6,2	9,0	12,4	12,4
Maximum unit current (3) (5)	A	40,9	47,1	53,9	62,7	82,5	91,5	116,8
Maximum unit inrush current (6)	A	116,7	135,3	155,7	182,1	159,5	174,7	217,2
Maximum unit current for wires sizing (7)	A	54,8	63,6	73,1	85,4	105,0	112,4	136,2

- (1) Nominal cooling capacity and power input are based on: 12/7 °C entering/leaving evaporator water temperature; 35°C ambient temperature.
- (2) Nominal heating capacity and power input are based on: 40/45 °C entering/leaving evaporator water temperature; 7°C(dry bulb)/6°C(wet bulb) ambient temperature.
- (3) Allowed voltage tolerance ± 10%. Voltage unbalance between phases must be within ± 3%.
- (4) Without pump.
- (5) Maximum current are based on: 15/10 °C entering/leaving evaporator water temperature and 48°C ambient temp.
- (6) Inrush current of biggest compressor + nominal absorbed current of the other compressors + fans current.
- (7) Compressor FLA + fans current.

Sound levels

Cooling only

McSmart	Sound pressure level at 1 m from the unit in free field (rif. 2×10^{-5})								
	63 Hz	125 Hz	250 Hz	500 Hz	1000 Hz	2000 Hz	4000 Hz	8000 Hz	dBA
160C	73,5	67,5	65,6	64,8	60,6	55,4	47,6	39,3	65,8
190C	73,1	69,8	63,8	64,6	62,9	57,7	53,6	48,7	67,0
210C	75,3	66,6	64,6	64,8	62,3	58,9	55,4	49,9	67,2
240C	75,3	66,6	64,1	64,5	62,4	58,7	52,9	45,7	66,9
320C	80,3	75,7	69,0	66,9	66,7	62,2	58,1	55,0	71,0
400C	80,4	72,1	69,0	68,9	65,9	62,4	57,8	51,3	71,0
500C	78,3	72,5	68,5	70,2	66,3	64,4	59,8	56,4	72,0

Average sound pressure level rated in accordance to ISO 3744, at free field semispherical conditions.

Heat pump

Unit size	Sound pressure level at 1 m from the unit in free field (rif. 2×10^{-5})								
	63 Hz	125 Hz	250 Hz	500 Hz	1000 Hz	2000 Hz	4000 Hz	8000 Hz	dBA
160CR	73,5	67,5	65,6	64,8	60,6	55,4	47,6	39,3	65,8
190CR	73,1	69,8	63,8	64,6	62,9	57,7	53,6	48,7	67,0
210CR	75,3	66,6	64,6	64,8	62,3	58,9	55,4	49,9	67,2
240CR	75,3	66,6	64,1	64,5	62,4	58,7	52,9	45,7	66,9
320CR	80,3	75,7	69,0	66,9	66,7	62,2	58,1	55,0	71,0
400CR	80,4	72,1	69,0	68,9	65,9	62,4	57,8	51,3	71,0
500CR	78,3	72,5	68,5	70,2	66,3	64,4	59,8	56,4	72,0

Average sound pressure level rated in accordance to ISO 3744, free field semispherical conditions.

Capacity performance

Cooling only

Unit size	Evaporator leaving temp. (°C)	AMBIENT TEMPERATURE - °C							
		21		25		30		32	
		Cooling capacity (kW)	Power input (kW)	Cooling capacity (kW)	Power input (kW)	Cooling capacity (kW)	Power input (kW)	Cooling capacity (kW)	Power input (kW)
160	5	51,6	14,9	49,5	15,9	48,2	16,5	47,3	16,9
	6	53,1	15,2	51,0	16,1	49,7	16,7	48,7	17,2
	7	54,5	15,6	52,4	16,4	51,0	17,0	50,1	17,4
	8	56,1	15,8	54,0	16,7	52,5	17,3	51,6	17,7
	9	57,8	15,7	55,4	16,9	54,0	17,5	53,0	17,9
	10	59,1	16,1	57,0	17,2	55,4	17,9	54,5	18,3
190	5	62,4	17,1	60,0	18,2	58,3	18,9	57,2	19,3
	6	64,4	17,5	61,7	18,5	60,1	19,2	59,0	19,7
	7	65,9	17,8	63,5	18,8	61,7	19,5	60,7	20,0
	8	67,8	18,1	65,3	19,1	63,5	19,8	62,4	20,3
	9	69,8	18,0	67,1	19,4	65,4	20,1	64,2	20,6
	10	71,6	18,5	69,1	19,7	67,2	20,5	65,9	21,0
210	5	75,9	19,6	73,0	20,9	71,0	21,7	69,7	22,2
	6	78,3	20,1	75,2	21,2	73,2	22,0	71,8	22,6
	7	80,3	20,5	77,3	21,6	75,3	22,4	73,8	22,9
	8	82,6	20,8	79,6	22,0	77,4	22,7	76,0	23,3
	9	85,1	20,6	81,8	22,2	79,6	23,1	78,1	23,6
	10	87,2	21,2	84,1	22,6	81,8	23,5	80,3	24,1
240	5	87,5	23,2	84,1	24,7	81,8	25,6	80,3	26,2
	6	90,2	23,7	86,6	25,1	84,3	26,0	82,7	26,7
	7	92,5	24,2	89,1	25,5	86,6	26,5	85,1	27,1
	8	95,1	24,6	91,6	25,9	89,1	26,9	87,5	27,5
	9	98,1	24,3	94,2	26,3	91,7	27,3	90,0	27,9
	10	100,5	25,1	96,9	26,7	94,2	27,8	92,5	28,4
320	5	105,6	30,4	101,5	32,4	98,7	33,6	96,9	34,4
	6	108,9	31,1	104,6	32,9	101,7	34,1	99,9	35,0
	7	111,6	31,7	107,5	33,5	104,6	34,7	102,7	35,5
	8	114,9	32,2	110,6	34,0	107,6	35,2	105,7	36,1
	9	118,3	31,9	113,7	34,4	110,7	35,7	108,7	36,6
	10	121,3	32,9	117,0	35,0	113,7	36,4	111,6	37,3
400	5	134,1	34,3	128,8	36,6	125,3	38,0	123,0	38,9
	6	138,2	35,1	132,7	37,2	129,2	38,6	126,7	39,5
	7	141,8	35,8	136,5	37,9	132,8	39,3	130,3	40,2
	8	145,8	36,4	140,4	38,5	136,6	39,8	134,1	40,8
	9	150,2	36,1	144,3	38,9	140,5	40,4	138,0	41,4
	10	153,8	37,2	148,4	39,6	144,4	41,2	141,8	42,2
500	5	167,0	42,5	160,5	45,3	156,1	47,0	153,2	48,1
	6	172,1	43,5	165,2	46,1	160,9	47,8	157,8	48,9
	7	176,4	44,4	169,9	46,9	165,3	48,6	162,4	49,8
	8	181,6	45,1	174,7	47,6	170,1	49,3	167,1	50,5
	9	187,0	44,7	179,7	48,2	175,0	50,0	171,8	51,2
	10	191,6	46,0	184,8	49,0	179,8	51,0	176,4	52,2

- Notes:** (1) Rating based on: evaporator fouling factor of 0,0176 m²°C / kW, evaporator temperature drop of 5°C and sea level altitude.
(2) Interpolation is allowed. Extrapolation is not permitted. Please contact McQuay for performance outside the standard ratings.
(3) Power input values are referred to compressor only.

Capacity performance

Cooling only

Unit size	Evaporator leaving temp. (°C)	AMBIENT TEMPERATURE - °C							
		35		40		43		48	
		Cooling capacity (kW)	Power input (kW)	Cooling capacity (kW)	Power input (kW)	Cooling capacity (kW)	Power input (kW)	Cooling capacity (kW)	Power input (kW)
160	5	45,0	17,9	42,6	18,8	41,7	19,2	39,7	19,8
	6	46,4	18,1	44,0	19,1	43,1	19,4	41,2	20,5
	7	47,8	18,4	45,3	19,3	44,3	19,7	42,0	20,7
	8	49,1	18,7	46,6	19,6	45,6	20,0	43,4	21,0
	9	50,5	19,0	48,0	19,9	46,9	20,1	44,8	19,7
	10	52,0	19,3	49,6	20,0	48,1	20,4	45,8	20,9
190	5	54,5	20,5	51,7	21,6	50,5	22,0	48,1	22,7
	6	56,2	20,8	53,2	21,9	52,1	22,3	49,9	23,5
	7	57,9	21,1	54,8	22,2	53,7	22,6	50,9	23,7
	8	59,5	21,4	56,4	22,5	55,2	22,9	52,5	24,0
	9	61,1	21,7	58,1	22,8	56,8	23,1	54,3	22,6
	10	62,9	22,1	60,0	23,0	58,3	23,4	55,4	23,9
210	5	66,4	23,5	62,9	24,7	61,5	25,2	58,6	26,0
	6	68,4	23,9	64,8	25,1	63,4	25,6	60,7	26,9
	7	70,5	24,2	66,8	25,4	65,3	26,0	62,0	27,2
	8	72,6	24,5	68,7	25,8	67,2	26,3	63,9	27,6
	9	74,4	24,9	70,7	26,1	69,2	26,4	66,2	26,0
	10	76,7	25,3	73,1	26,3	71,0	26,8	67,5	27,4
240	5	76,6	27,8	72,5	29,2	70,8	29,8	67,4	30,7
	6	78,8	28,2	74,7	29,6	73,1	30,2	70,0	31,8
	7	81,2	28,6	77,0	30,1	75,2	30,7	71,3	32,1
	8	83,5	29,0	79,1	30,5	77,4	31,1	73,6	32,6
	9	85,8	29,5	81,5	30,9	79,7	31,3	76,2	30,7
	10	88,3	29,9	84,2	31,1	81,7	31,7	77,8	32,4
320	5	92,3	36,4	87,5	38,3	85,6	39,1	81,5	40,3
	6	95,1	37,0	90,2	38,8	88,2	39,6	84,4	41,7
	7	98,0	37,5	92,8	39,4	90,8	40,2	86,2	42,1
	8	100,8	38,0	95,6	40,0	93,5	40,8	88,8	42,7
	9	103,5	38,6	98,3	40,5	96,3	41,0	92,0	40,2
	10	106,6	39,2	101,5	40,8	98,7	41,5	93,9	42,5
400	5	117,2	41,2	111,0	43,3	108,6	44,2	103,3	45,6
	6	120,6	41,8	114,5	43,9	111,9	44,8	107,1	47,2
	7	124,3	42,4	117,8	44,6	115,2	45,5	109,3	47,6
	8	128,0	43,0	121,3	45,2	118,7	46,1	112,8	48,3
	9	131,4	43,7	124,7	45,8	122,1	46,3	116,8	45,5
	10	135,2	44,4	128,9	46,1	125,2	47,0	119,2	48,1
500	5	145,9	51,0	138,2	53,6	135,2	54,7	128,8	56,4
	6	150,3	51,7	142,4	54,4	139,4	55,5	133,4	58,4
	7	154,8	52,3	146,8	55,2	143,5	56,3	136,1	59,0
	8	159,4	53,3	151,0	56,0	147,8	57,1	140,5	59,8
	9	163,6	54,1	155,3	56,7	152,1	57,4	145,4	56,3
	10	168,4	54,9	160,6	57,1	155,9	58,2	148,5	59,5

- Notes:** (1) Rating based on: evaporator fouling factor of 0,0176 m²°C / kW, evaporator temperature drop of 5°C and sea level altitude.
(2) Interpolation is allowed. Extrapolation is not permitted. Please contact McQuay for performance outside the standard ratings.
(3) Power input values are referred to compressor only.

Capacity performance

Heat pump

Unit size	Evaporator leaving temp. (°C)	AMBIENT TEMPERATURE - °C							
		21		25		30		32	
		Cooling capacity (kW)	Power input (kW)	Cooling capacity (kW)	Power input (kW)	Cooling capacity (kW)	Power input (kW)	Cooling capacity (kW)	Power input (kW)
160	5	50,8	14,8	48,8	15,8	47,6	16,4	46,6	16,8
	6	52,4	15,2	50,3	16,1	48,9	16,7	48,1	17,1
	7	53,8	15,5	51,8	16,3	50,4	16,9	49,5	17,3
	8	55,3	15,7	53,2	16,6	51,8	17,2	50,8	17,6
	9	56,9	15,6	54,7	16,8	53,2	17,4	52,3	17,9
	10	58,4	16,0	56,3	17,1	54,7	17,8	53,8	18,2
190	5	57,0	16,3	54,8	17,3	53,3	18,0	52,4	18,4
	6	58,8	16,7	56,5	17,6	55,0	18,3	54,0	18,7
	7	60,3	17,0	58,1	17,9	56,5	18,6	55,4	19,1
	8	62,1	17,3	59,7	18,2	58,2	18,9	57,1	19,3
	9	63,9	17,1	61,4	18,5	59,7	19,2	58,7	19,6
	10	65,5	17,6	63,2	18,8	61,4	19,5	60,3	20,0
210	5	68,6	19,0	65,9	20,2	64,2	20,9	63,0	21,5
	6	70,8	19,4	67,9	20,5	66,2	21,3	64,9	21,8
	7	72,6	19,8	69,8	20,9	67,9	21,7	66,7	22,2
	8	74,7	20,1	71,8	21,2	69,9	22,0	68,7	22,5
	9	76,9	19,9	73,8	21,5	71,9	22,3	70,6	22,8
	10	78,8	20,5	75,9	21,8	73,9	22,7	72,6	23,3
240	5	81,6	22,0	78,3	23,4	76,3	24,3	74,9	24,8
	6	84,1	22,5	80,8	23,8	78,6	24,7	77,2	25,3
	7	86,2	22,9	83,1	24,2	80,9	25,1	79,3	25,7
	8	88,8	23,3	85,5	24,6	83,1	25,5	81,6	26,1
	9	91,3	23,1	87,8	24,9	85,5	25,8	83,9	26,4
	10	93,7	23,8	90,3	25,3	87,8	26,3	86,2	27,0
320	5	103,4	28,8	99,4	30,6	96,7	31,8	94,9	32,5
	6	106,7	29,4	102,5	31,1	99,6	32,3	97,9	33,1
	7	109,4	30,0	105,3	31,7	102,5	32,9	100,6	33,7
	8	112,6	30,5	108,4	32,2	105,4	33,4	103,5	34,2
	9	115,9	30,2	111,4	32,6	108,5	33,8	106,5	34,6
	10	118,8	31,1	114,6	33,1	111,4	34,5	109,4	35,3
400	5	121,4	33,2	116,7	35,4	113,5	36,7	111,4	37,6
	6	125,2	34,0	120,1	36,0	117,0	37,3	114,8	38,2
	7	128,3	34,6	123,6	36,6	120,2	38,0	118,0	38,9
	8	132,0	35,2	127,1	37,2	123,7	38,5	121,4	39,5
	9	136,0	34,9	130,6	37,7	127,2	39,1	124,8	40,0
	10	139,3	35,9	134,3	38,3	130,7	39,8	128,3	40,8
500	5	156,1	41,1	150,0	43,7	145,9	45,4	143,3	46,5
	6	160,9	42,0	154,5	44,5	150,4	46,1	147,6	47,3
	7	165,0	42,8	158,9	45,3	154,6	46,9	151,8	48,1
	8	169,8	43,5	163,4	46,0	159,1	47,6	156,2	48,8
	9	174,8	43,2	168,0	46,6	163,5	48,3	160,6	49,5
	10	179,1	44,5	172,7	47,3	168,1	49,2	165,0	50,4

- Notes:** (1) Rating based on: evaporator fouling factor of 0,0176 m²°C / kW, evaporator temperature drop of 5°C and sea level altitude.
(2) Interpolation is allowed. Extrapolation is not permitted. Please contact McQuay for performance outside the standard ratings.
(3) Power input values are referred to compressor only.

Capacity performance

Heat pump

Unit size	Evaporator leaving temp. (°C)	AMBIENT TEMPERATURE - °C							
		35		40		43		48	
		Cooling capacity (kW)	Power input (kW)	Cooling capacity (kW)	Power input (kW)	Cooling capacity (kW)	Power input (kW)	Cooling capacity (kW)	Power input (kW)
160	5	44,4	17,8	42,1	18,7	41,2	19,1	39,2	19,7
	6	45,8	18,0	43,4	19,0	42,4	19,3	40,6	20,4
	7	47,1	18,3	44,7	19,2	43,7	19,6	41,5	20,5
	8	48,5	18,6	46,0	19,5	44,9	19,9	42,7	20,9
	9	49,8	18,8	47,4	19,8	46,3	20,0	44,3	19,6
	10	51,2	19,1	48,9	19,9	47,5	20,3	45,2	20,7
190	5	49,9	19,5	47,3	20,5	46,2	20,9	44,0	21,6
	6	51,3	19,8	48,7	20,8	47,7	21,2	45,6	22,4
	7	52,9	20,1	50,2	21,1	49,0	21,6	46,5	22,6
	8	54,5	20,4	51,7	21,4	50,5	21,8	48,0	22,9
	9	56,0	20,7	53,1	21,7	52,0	22,0	49,7	21,6
	10	57,5	21,0	54,9	21,9	53,3	22,3	50,7	22,8
210	5	60,0	22,7	56,8	23,9	55,5	24,4	52,9	25,1
	6	61,7	23,1	58,6	24,2	57,2	24,7	54,8	26,0
	7	63,6	23,4	60,3	24,6	59,0	25,1	56,0	26,3
	8	65,5	23,7	62,1	25,0	60,7	25,4	57,8	26,7
	9	67,2	24,1	63,8	25,3	62,5	25,6	59,7	25,1
	10	69,2	24,5	65,9	25,5	64,1	25,9	61,0	26,5
240	5	71,3	26,3	67,5	27,7	66,1	28,2	62,8	29,1
	6	73,4	26,7	69,6	28,1	68,2	28,6	65,2	30,1
	7	75,6	27,1	71,6	28,5	70,2	29,1	66,5	30,4
	8	77,9	27,5	73,8	28,9	72,3	29,5	68,7	30,9
	9	80,0	27,9	76,0	29,3	74,4	29,6	71,0	29,1
	10	82,3	28,4	78,4	29,5	76,2	30,0	72,6	30,7
320	5	90,5	34,5	85,7	36,3	83,8	37,0	79,8	38,1
	6	93,1	35,0	88,3	36,8	86,4	37,5	82,7	39,5
	7	96,0	35,5	90,9	37,3	88,9	38,1	84,4	39,9
	8	98,8	36,0	93,7	37,9	91,6	38,6	87,0	40,5
	9	101,4	36,6	96,3	38,3	94,3	38,8	90,1	38,1
	10	104,4	37,1	99,5	38,6	96,6	39,3	92,0	40,2
400	5	106,1	39,8	100,5	41,9	98,3	42,7	93,6	44,1
	6	109,2	40,4	103,5	42,5	101,3	43,3	97,0	45,6
	7	112,6	41,0	106,7	43,1	104,4	44,0	99,0	46,0
	8	115,8	41,6	109,8	43,7	107,4	44,6	102,2	46,7
	9	119,0	42,2	113,0	44,3	110,6	44,8	105,6	44,0
	10	122,4	42,9	116,7	44,6	113,4	45,4	107,9	46,5
500	5	136,5	49,2	129,3	51,8	126,5	52,8	120,4	54,5
	6	140,5	50,0	133,2	52,5	130,3	53,6	124,7	56,4
	7	144,7	50,7	137,3	53,3	134,1	54,4	127,4	56,9
	8	149,0	51,4	141,2	54,1	138,1	55,1	131,3	57,8
	9	152,9	52,2	145,3	54,8	142,2	55,4	135,9	54,4
	10	157,5	53,0	150,1	55,1	145,8	56,2	138,8	57,5

- Notes:** (1) Rating based on: evaporator fouling factor of 0,0176 m²°C / kW, evaporator temperature drop of 5°C and sea level altitude.
(2) Interpolation is allowed. Extrapolation is not permitted. Please contact McQuay for performance outside the standard ratings.
(3) Power input values are referred to compressor only.

Capacity performance

Heat pump

Unit size	Leaving water temperature (°C)	AMBIENT TEMPERATURE - °C									
		-5		0		5		7		10	
		Heating capacity (kW)	Power input (kW)	Heating capacity (kW)	Power input (kW)	Heating capacity (kW)	Power input (kW)	Heating capacity (kW)	Power input (kW)	Heating capacity (kW)	Power input (kW)
160	35	41,9	14,8	48,5	16,0	55,7	17,2	58,5	17,6	62,9	18,1
	40	40,2	15,2	46,8	16,2	54,1	17,7	56,8	18,3	61,2	19,1
	45	38,6	15,6	45,3	17,0	52,4	18,5	55,1	19,5	59,5	19,9
	50	37,0	16,0	43,6	17,6	50,7	19,1	53,4	19,7	57,9	20,3
	55	35,3	16,4	41,9	18,1	49,0	19,7	51,9	19,9	56,3	20,5
190	35	43,4	15,7	50,3	17,0	57,6	18,2	60,6	18,6	65,1	19,3
	40	41,7	16,1	48,5	17,2	56,0	18,8	58,8	19,5	63,4	20,3
	45	40,0	16,6	46,8	18,0	54,3	19,7	57,1	20,7	61,7	21,1
	50	38,2	17,0	45,2	18,6	52,5	20,3	55,4	20,9	60,0	21,5
	55	36,5	17,4	43,4	19,3	50,8	20,9	53,7	21,1	58,3	21,7
210	35	51,0	19,5	59,1	21,0	67,8	22,5	71,2	23,0	76,7	23,8
	40	49,0	20,0	57,1	21,2	65,8	23,3	69,2	24,1	74,6	25,1
	45	47,0	20,5	55,1	22,3	63,8	24,3	67,2	25,6	72,6	26,1
	50	45,0	21,0	53,1	23,0	61,8	25,1	65,2	25,9	70,6	26,6
	55	43,1	21,5	51,0	23,8	59,9	25,9	63,2	26,1	68,6	26,9
240	35	62,2	21,7	72,0	23,4	82,6	25,1	86,7	25,7	93,2	26,5
	40	59,8	22,2	69,5	23,7	80,2	25,9	84,3	26,8	90,8	27,9
	45	57,3	22,8	67,0	24,8	77,7	27,1	81,8	28,5	88,4	29,1
	50	54,7	23,4	64,6	25,7	75,2	27,9	79,3	28,8	85,9	29,6
	55	52,3	23,9	62,2	26,5	72,8	28,8	76,9	29,1	83,4	29,9
320	35	83,8	29,0	97,0	31,2	111,4	33,5	116,9	34,3	125,7	35,4
	40	80,5	29,7	93,8	31,6	108,0	34,7	113,6	35,8	122,4	37,3
	45	77,2	30,5	90,4	33,1	104,8	36,2	110,3	38,1	119,1	38,9
	50	73,9	31,2	87,2	34,3	101,4	37,3	107,0	38,5	115,8	39,6
	55	70,6	32,0	83,8	35,4	98,2	38,5	103,6	38,9	112,5	40,0
400	35	89,8	34,5	104,0	37,2	119,3	40,0	125,3	40,9	134,7	42,2
	40	86,2	35,4	100,4	37,7	115,8	41,3	121,7	42,7	131,1	44,5
	45	82,7	36,3	96,9	39,5	112,2	43,1	118,1	45,4	127,6	46,3
	50	79,2	37,2	93,3	40,9	108,7	44,5	114,6	45,9	124,0	47,2
	55	75,6	38,2	89,8	42,3	105,1	46,0	111,1	46,4	120,5	47,8
500	35	119,7	43,5	138,6	47,0	159,1	50,4	167,0	51,6	179,6	53,3
	40	114,9	44,7	133,8	47,6	154,3	52,1	162,3	53,9	174,7	56,2
	45	110,3	45,8	129,2	49,9	149,7	54,4	157,5	57,3	170,1	58,4
	50	105,5	47,0	124,4	51,6	144,8	56,2	152,7	57,9	165,3	59,6
	55	100,8	48,1	119,7	53,3	140,2	57,9	148,1	58,4	160,7	60,2

- Notes:** (1) Rating based on: evaporator fouling factor of 0,0176 m²°C / kW, evaporator temperature drop of 5°C and sea level altitude.
(2) Interpolation is allowed. Extrapolation is not permitted. Please contact McQuay for performance outside the standard ratings.
(3) Power input values are referred to compressor only.

Refrigerant and hydraulic circuits

COOLING ONLY

McSmart 160C - 190C

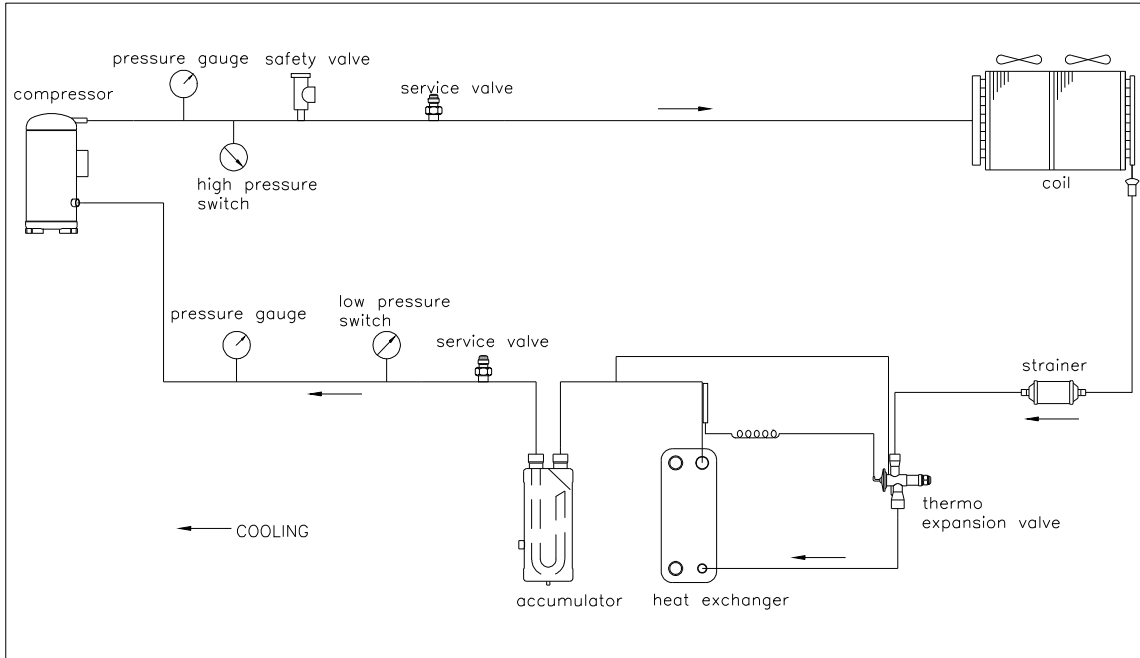

McSmart 210C - 240C - 320C - 400C - 500C

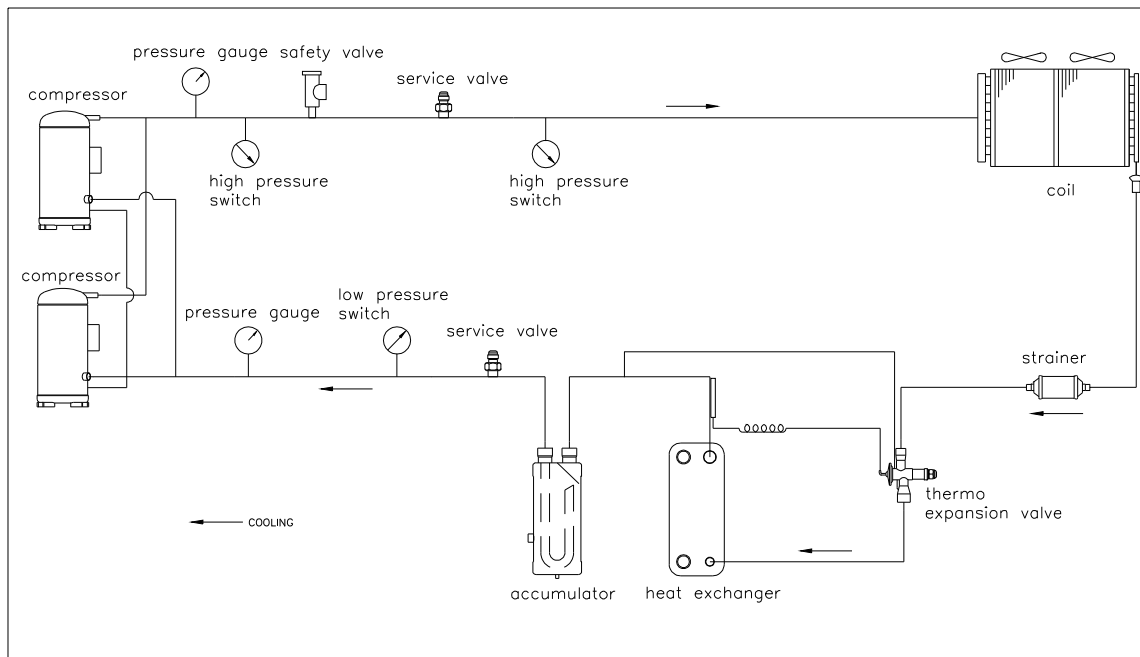

Refrigerant and hydraulic circuits

HEAT PUMP

McSmart 160CR - 190CR

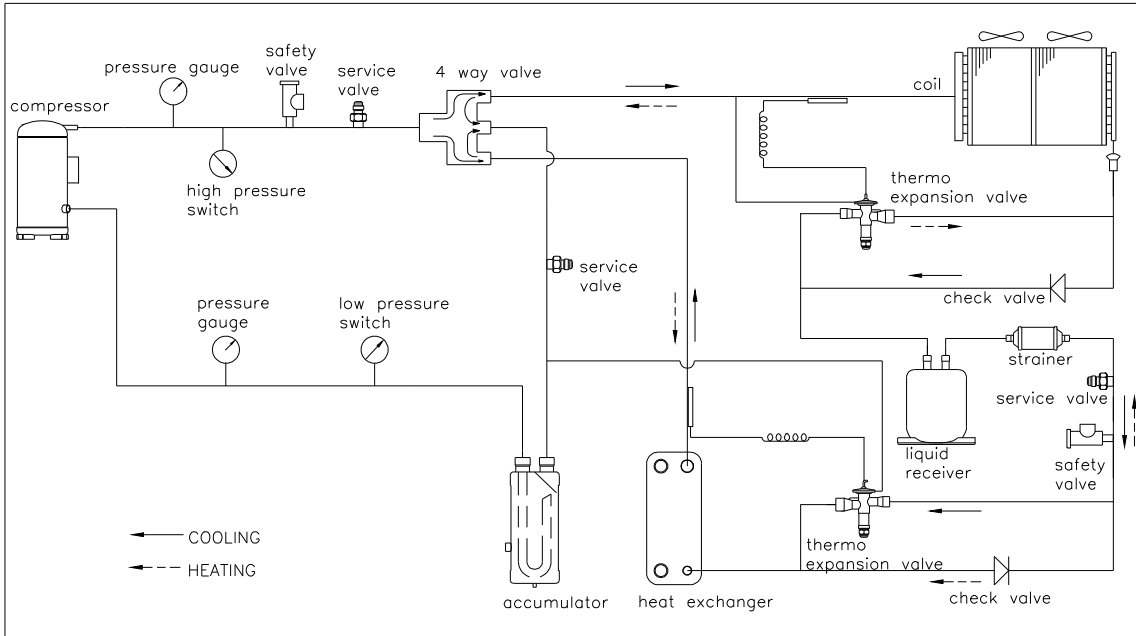

McSmart 210CR - 240CR - 320CR - 400CR - 500CR

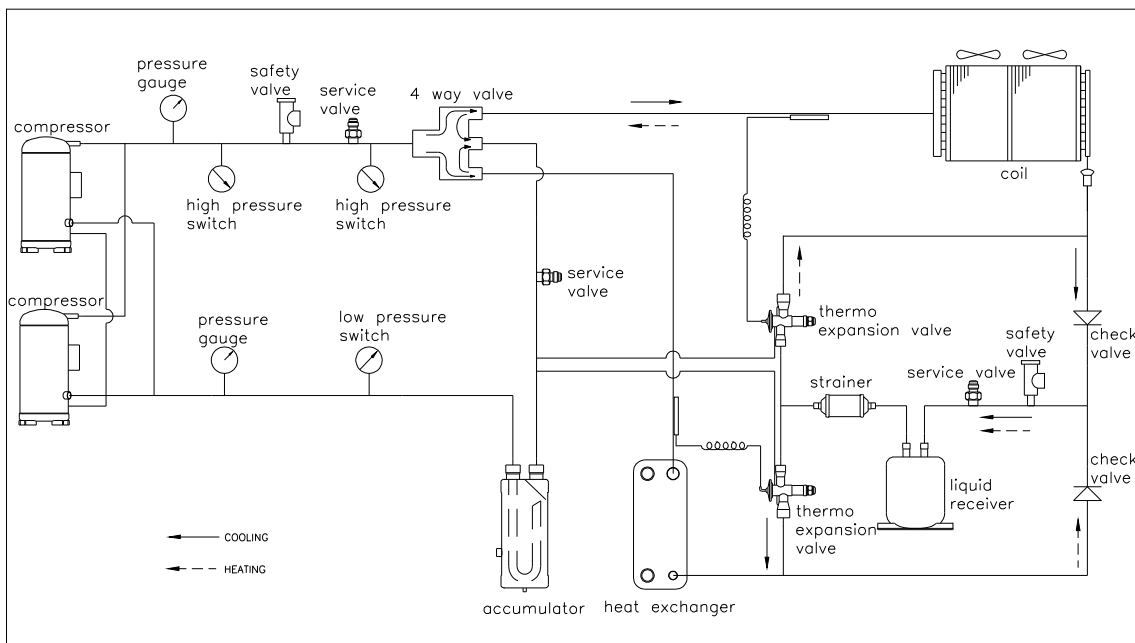

Installation

Handling and space requirements

Handling

All moving and handling may damage the unit if some conditions are not scrupulously observed. The units should be lifted with a crane using long ropes anchored to the holes on the frame of the unit's base and by using the upper spacer bars to prevent the ropes from damaging the condenser coils.

Location

McSmart units are produced for outside installation on roofs, floors or below ground level on condition that the area is free from obstacles for the passage of the condensation air. The unit should be positioned on solid foundations and perfectly level; in the case of installation on roofs or floors, it may be advisable to arrange the use of suitable weight distribution beams. When the units are installed on the ground, a concrete base at least 250 mm wider and longer than the unit's footprint should be laid. Furthermore, this base should be sufficiently robust to withstand the unit weight mentioned in the technical data table.

Space requirements

McSmart units are air-cooled, hence it is important to observe the minimum distances which guarantee the best ventilation of the condenser coils. Limitations of space reducing the air flow could cause significant reductions in cooling capacity, and increase in electricity consumption. The fans do not allow the use of ducts which have high flow resistance, hence it should be ensured that the output air cannot recycle itself inside the condenser coils. The units should be positioned such that there is sufficient distance between the coils and any obstacles to improve ventilation and also to facilitate inspection (fig. 1).

When two or more units are positioned side by side it is recommended that the condenser coils are at least 2500mm distance from one another (fig. 2). Smaller distances could cause the recirculation of hot air. If the units are positioned in places surrounded by walls or obstacles of the same height as the units, the units should be at least 2000mm from said obstacles (fig. 3). In the event the obstacles are higher than the units, the units should be at least 2500mm from the obstacle (fig. 4). For other installation solutions, consult McQuay technicians.

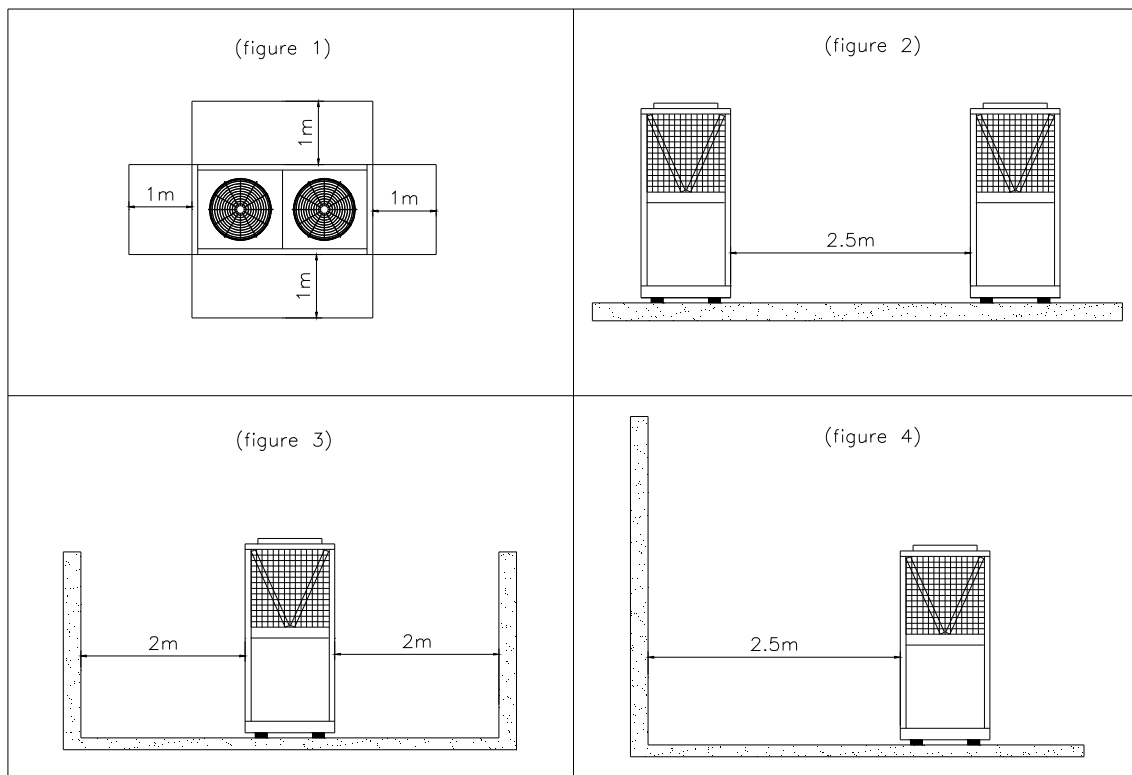

Installation

Dimensions

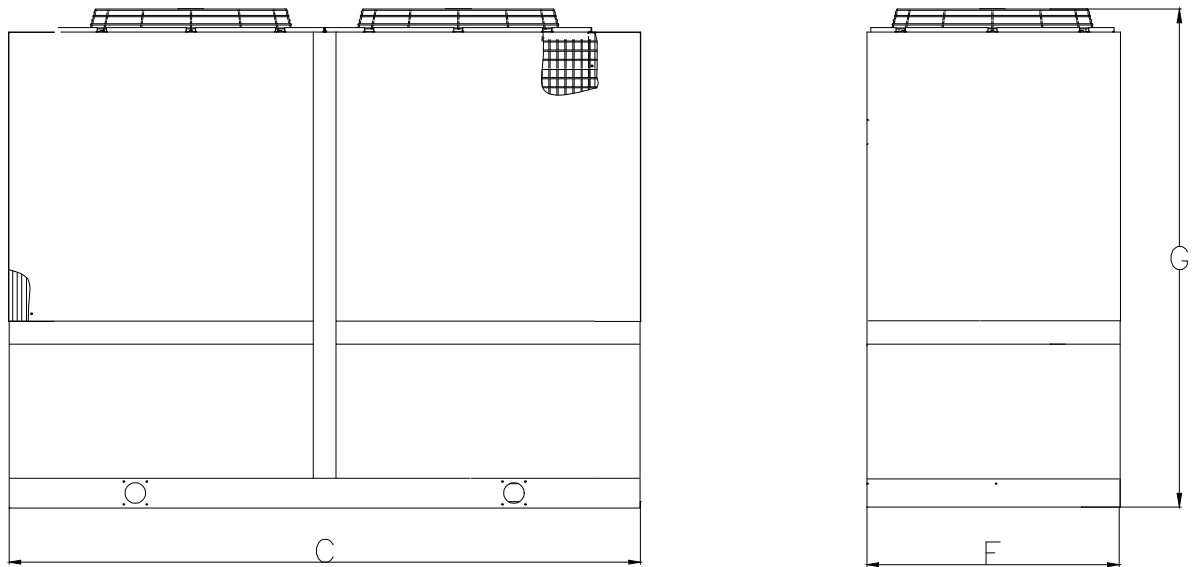

McSmart	C (mm)	F (mm)	G (mm)
160÷190	1820	1000	1935
210÷240	2056	1153	2185
320	2750	1100	2180

Installation

Dimensions

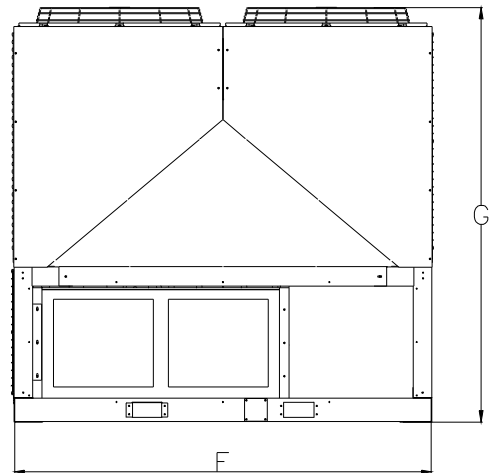
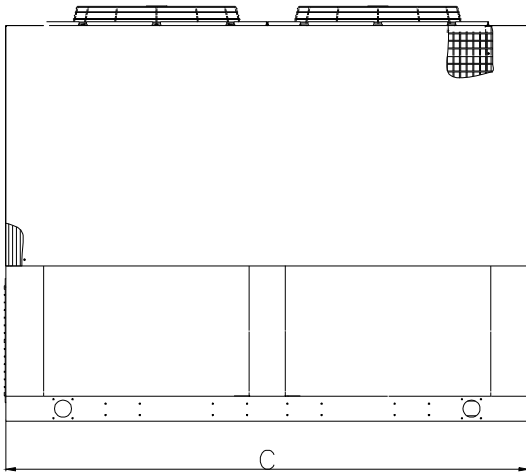

McSmart	C (mm)	F (mm)	G (mm)
400÷500	2750	2200	2180

Installation

Electrical connections

General rules

The chillers must be well grounded. It absolutely cannot be connected with gas-pipe, water pipe and telephone line.

Ensure that the rated voltage of the unit corresponds to that of the name plate before general precautions.

Provide a power outlet to be used exclusively for each unit. A power supply disconnects and a circuit breaker for over-current protection should be provided in the exclusive line.

Electric wiring data for cooling only

McSmart		160C	190C	210C	240C	320C	400C	500C	
Power		400 V – 3ph + N – 50 Hz							
Power input (kW)	Cooling	18,4	21,1	24,2	28,6	37,5	42,4	52,3	
Operation current (A)	Cooling	32,8	36,7	43,2	50,1	69,8	76,7	100,5	
Power line									
Power line	Line (R/S/T)	Section area (mm ²)	16	16	25	25	35	50	50
		number	3	3	3	3	3	3	3
	Neutral Line	Section area (mm ²)	6	6	6	6	25	35	35
		number	1	1	1	1	1	1	1
	Earth Line	Section area (mm ²)	16	16	25	25	35	50	50
		number	1	1	1	1	1	1	1

Every wire can not contact pipes, compressor, fan motor or other movable parts.

Wires should be well connected.

Electric wiring data for heat pump

McSmart		160CR	190CR	210CR	240CR	320CR	400CR	500CR	
Power		400 V – 3ph + N – 50 Hz							
Power input (kW)	Cooling	18,3	20,1	23,4	27,1	35,5	41,0	50,7	
	Heating	19,5	20,7	25,6	28,5	38,1	45,4	57,3	
Operation current (A)	Cooling	32,6	35,8	41,9	49,7	66,1	74,2	97,4	
	Heating	34,7	36,8	45,9	52,3	70,9	82,1	110,1	
Power line									
Power line	Line (R/S/T)	Section area (mm ²)	16	16	25	25	35	50	50
		number	3	3	3	3	3	3	3
	Neutral Line	Section area (mm ²)	6	6	6	6	25	35	35
		number	1	1	1	1	1	1	1
	Earth Line	Section area (mm ²)	4	4	4	4	35	50	50
		number	1	1	1	1	1	1	1

Every wire can not contact pipes, compressor, fan motor or other movable parts.

Wires should be well connected.

Installation

Water circuit

General rules

Be sure to use clean water when filling in the water circuit to avoid heavy corrosion and choking of the system. If the chiller is operated under very oily, salty or acidic atmosphere or water, these substances may lead to capacity drop or failure of the unit.

Prior to starting up the unit, flushing of the water system is required.

Water flow should not be lower than the nominal value of the unit.

Water content in cooling circuits

The cooled water distribution circuits should have a minimum water content to avoid excessive compressors start and stop.

To prevent damage to the compressors, the controller limits frequent stops and restarts.

During one hour there will be no more than 10 starts for each compressor. The plant side should therefore ensure that the overall water content allows more constant functioning of the unit and consequently greater environmental comfort. The minimum installation water content envisaged per unit should be calculated with a certain approximation using this simplified formula:

$$(1) \quad Q = 43 \frac{P \text{ (kW)}}{\Delta T \text{ (°C)}} \times \frac{1}{N}$$

where:

Q = Minimum content per unit in litres

P = Unit cooling capacity in kW

N = reduction steps number

ΔT = temperature difference to be selected according to the following table

Reduction steps number	ΔT
1	7,5
2	5,0
3	4,2
4	4,0

For more accurate calculation of water quantity, it is advisable to contact the designer of the plant.

Installation

Evaporator pressure drops

McSmart 160÷500 C / CR

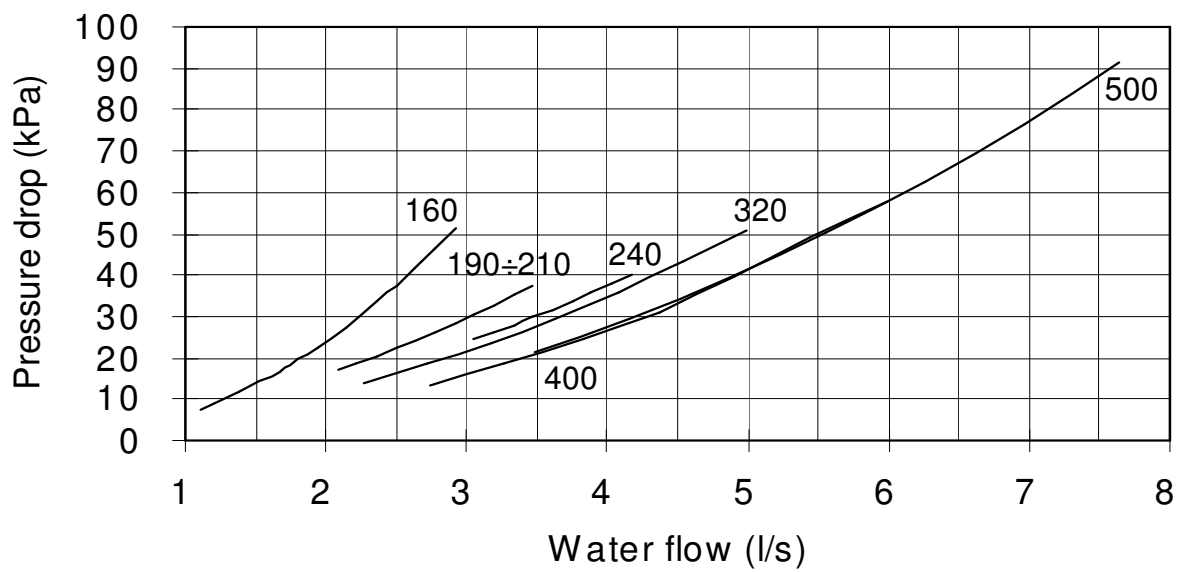

Installation

Water pump available lift

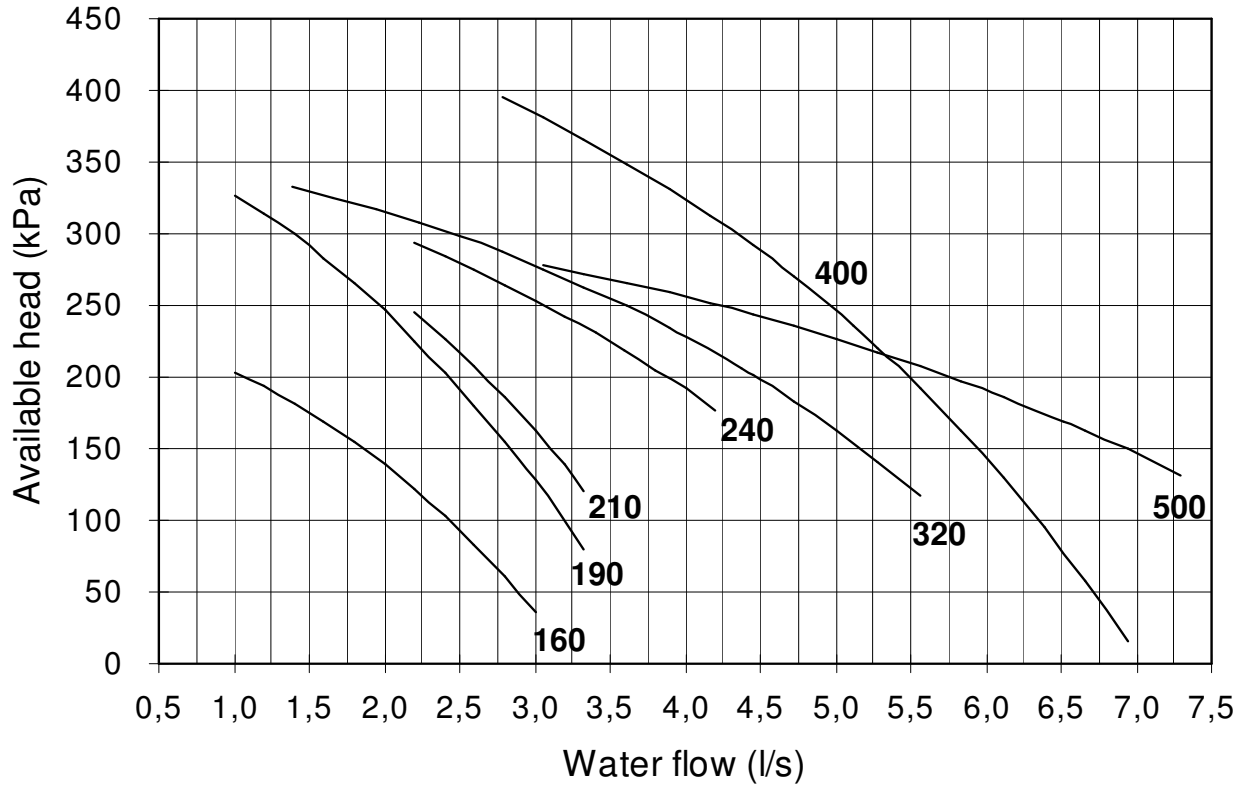

Pumps data

McSmart	Power input (kW)	AMPS	IP	Power supply
160	0,75	2,00	54	400V/3ph/50Hz
190÷210	1,10	2,80	54	400V/3ph/50Hz
240÷320	1,85	4,95	54	400V/3ph/50Hz
400	2,50	5,85	54	400V/3ph/50Hz
500	3,00	6,10	55	400V/3ph/50Hz

Maintenance

General rules

Maintenance is of extreme importance if the plant is to operate in a regular way and give fade-free service. Have extraordinary maintenance work done by qualified and authorized personnel. Comply with the safety precautions given in the relative section of this manual and take all the necessary precautions.

The following information is only a guide for the end user.

Routine maintenance

The inspections described below to which the unit must be subjected do not require specific technical know-how.

They merely include a few simple checks involving certain parts of the unit.

Call an authorized assistance centre if actual maintenance work is required.

The table below gives a recommended list of inspections which should be carried out at the indicated frequencies.

DESCRIPTION	WEEKLY	MONTHLY	EVERY SIX MONTHS
Visual inspection of the structure of the unit			•
Inspection of the hydraulic circuit		•	
Inspection of the electrical system		•	
Inspection of the condensing section		•	
Reading and recording of operating parameters	•		

Visual inspection of the structure of the unit

When checking the condition of the parts that form the structure of the unit, pay particular attention to the parts liable to rust. If traces of rust are noted, they must be treated with rust-inhibitor paint in order to eliminate or reduce the problem. Check to make sure that the external panels of the unit are well fixed.

Bad fixing gives rise to noise to noise and abnormal vibrations.

Inspection of the hydraulic circuit

Check visually to make sure that there are no leaks in the hydraulic circuit. And the water filter is clean.

Inspection of the electrical system

Make sure that the power cable that connects the unit to the distribution panel is not torn, cracked or damaged in a way that could impair its insulation.

Inspection of the condensing section

WARNING: The finned pack exchanger has fins made of aluminium, thus even accidental contact could cause cuts. Comply with the instructions in the relative section.

Condensing bank

In view of the function of this component, it is very important for the surface of the exchanger to be as free as possible from clogging caused by items that could reduce the air flow rate of the fan and, thus, the performances of the unit itself. The following operations may be required:

Remove all impurities (such as paper scraps, leaves, etc., etc.) that could be clogging the surface of the bank either by hand or using a brush (comply with the above mentioned safety prescriptions).

If the dirt has deposited on the fins and is difficult to remove by hand, use a jet of compressed air or pressurized water in the aluminium bank surface, remembering to direct the jet in a vertical direction to prevent the fins from being damaged.

“Comb” the bank with the relative tool, using the appropriate comb spacing for the fins if some parts of them are bent or squashed.

Helical electric fans

Visually inspect these parts to make sure that the electric fans are well fixed to the bearing grille and that this latter is fixed to the structure of the unit. Bad fixing leads to noise and abnormal vibrations.

Safety

The machine has been designed to reduce risks to persons and to the environment in which it is installed, to the minimum. To eliminate residue hazards, it is therefore advisable to become as familiar as possible with the machine in order to avoid accidents that could cause injuries to persons and/or damage to the property.

a. Access to the unit

Only qualified persons who are familiar with this type of machine and who are equipped with the necessary safety protections (footwear, gloves, helmet, etc.) may be allowed to access the machine. Moreover, in order to operate, these persons must have been authorized by the owner of the machine and be recognized by the Manufacturer itself.

b. Elements of risk

The machine has been designed and built so as not to create any condition of risk. However, residue hazards are impossible to eliminate during the planning phase are therefore listed in the following table along with the instructions on how to neutralize them.

Part question	Residue hazard	Mode	Precautions
Compressor and delivery pipe	Burns	Contact with the pipes and/or the compressor	Avoid contact by wearing protective gloves
Pipes in general	Ice burns	Leaking coolant	Do not exercise tension on the pipes
Heat exchange bank	Cuts	Contact	Wear protective gloves
Electric fans	Cuts	Contact with the skin	Do not push the hands or objects through the fan grille



- **Installation and maintenance are to be performed only by qualified personnel who are familiar with local codes and regulations, and experienced with this type of equipment.**
- **Moving machine and electrical power is hazardous. May cause severe personal injury or death. Disconnect and lock off power before servicing equipment.**

We reserve the right to make changes in design and construction at any time without notice, thus the cover picture is not binding.

McQuay partecipa al programma di
Certificazione Eurovent.
I prodotti interessati figurano nella Guida
Eurovent dei Prodotti Certificati.



The logo for Eurovent Certified Performance is a black inverted triangle. Inside the triangle, there is a white stylized 'e' with a horizontal line through its center. Above the triangle, the words 'EUROVENT' and 'CERTIFIED PERFORMANCE' are written in a small, sans-serif font.

McQuay is participating in the Eurovent
Certification Programme
Product are as listed in the Eurovent
Directory of Certified Products

McQuay[®]
International

McQuay Italia S.P.A.

S.S. Nettunense, km 12+300 – 00040 Cecchina (Roma) Italia – Tel. (06) 937311 – Fax (06) 9374014 – email: info@mcquayeuropa.com

www.mcquayeuropa.com